

Dimensions for *Martin* sheaves are listed in the following tables with QD bushings in place. The type of sheave shown below is indicated by a letter, and the construction is indicated by a number, as shown on facing page.

## QD Sheaves — 3V

1 Groove*											2 Groove										
F = 1/16											F = 1/32										
Part Number	OD	PD 3V Belt	Type	Bush	Bush Max. Bore	E ☆	K	L Length Thru Bore	M ☆	Wt. Less Bush	Part Number	Type	Bush	Bush Max. Bore	E ☆	K	L Length Thru Bore	M ☆	Wt. Less Bush		
1 3V 220 JA	2.20	2.15	E-1	JA	1 1/4	3/16	7/16	1 1/16	1 1/16	.7	2 3V 220 JA	E-1	JA	1 1/4	3/32	7/16	1 1/16	1 1/16	.9		
1 3V 235 JA	2.35	2.30	E-1	JA	1 1/4	3/16	7/16	1 1/16	1 1/16	.8	2 3V 235 JA	E-1	JA	1 1/4	3/32	7/16	1 1/16	1 1/16	1.0		
1 3V 250 JA	2.50	2.45	E-1	JA	1 1/4	3/16	7/16	1 1/16	1 1/16	.8	2 3V 250 JA	E-1	JA	1 1/4	3/32	7/16	1 1/16	1 1/16	1.2		
1 3V 265 JA	2.65	2.60	C-1	JA	1 1/4	3/8	1/2	1 1/16	0	.9	2 3V 265 JA	D-1	JA	1 1/4	3/8	1/2	1 1/16	1 1/16	1.3		
1 3V 280 JA	2.80	2.75	C-1	JA	1 1/4	3/8	1/2	1 1/16	0	.9	2 3V 280 JA	D-1	JA	1 1/4	3/8	1/2	1 1/16	1 1/16	1.4		
1 3V 300 JA	3.00	2.95	C-1	JA	1 1/4	3/8	1/2	1 1/16	0	1.0	2 3V 300 JA	D-1	JA	1 1/4	3/8	1/2	1 1/16	1 1/16	1.6		
1 3V 315 JA	3.15	3.10	C-1	JA	1 1/4	3/8	1/2	1 1/16	0	1.0	2 3V 315 JA	D-1	JA	1 1/4	3/8	1/2	1 1/16	1 1/16	1.8		
1 3V 335 JA	3.35	3.30	C-1	JA	1 1/4	3/8	1/2	1 1/16	0	1.1	2 3V 335 SH	D-1	SH	1 1/16	7/64	3/4	1 1/16	1 1/16	2.0		
1 3V 365 SH	3.65	3.60	D-1	SH	1 1/16	3/16	0	1 1/16	1/16	1.3	2 3V 365 SH	D-1	SH	1 1/16	7/64	3/4	1 1/16	1 1/16	2.4		
1 3V 412 SH	4.12	4.07	D-1	SH	1 1/16	3/16	0	1 1/16	1/16	1.7	2 3V 412 SH	D-1	SH	1 1/16	9/32	3/4	1 1/16	1 1/16	2.7		
1 3V 450 SH	4.50	4.45	D-2	SH	1 1/16	3/16	0	1 1/16	1/16	2.1	2 3V 450 SH	D-1	SH	1 1/16	1/4	3/16	1 1/16	1 1/16	2.9		
1 3V 475 SH	4.75	4.70	D-2	SH	1 1/16	3/16	0	1 1/16	1/16	2.5	2 3V 475 SH	D-1	SH	1 1/16	1/4	3/16	1 1/16	1 1/16	3.1		
1 3V 500 SH	5.00	4.95	D-2	SH	1 1/16	3/16	0	1 1/16	1/16	2.8	2 3V 500 SH	D-1	SH	1 1/16	1/4	3/16	1 1/16	1 1/16	3.6		
1 3V 530 SH	5.30	5.25	D-2	SH	1 1/16	3/16	0	1 1/16	1/16	3.2	2 3V 530 SH	D-1	SH	1 1/16	1/4	3/16	1 1/16	1 1/16	4.5		
1 3V 560 SH	5.60	5.55	D-2	SH	1 1/16	3/16	0	1 1/16	1/16	3.2	2 3V 560 SH	D-1	SH	1 1/16	1/4	3/16	1 1/16	1 1/16	5.0		
1 3V 600 SH	6.00	5.95	D-2	SH	1 1/16	3/16	0	1 1/16	1/16	3.5	2 3V 600 SH	D-1	SH	1 1/16	1/4	3/16	1 1/16	1 1/16	5.5		
1 3V 650 SH	6.50	6.45	D-3	SH	1 1/16	3/16	0	1 1/16	1/16	3.9	2 3V 650 SDS	D-3	SDS	2	3/16	3/16	1 1/16	1 1/16	5.8		
1 3V 690 SH	6.90	6.85	D-3	SH	1 1/16	3/16	0	1 1/16	1/16	4.5	2 3V 690 SDS	D-3	SDS	2	3/16	3/16	1 1/16	1 1/16	6.6		
1 3V 800 SDS	8.00	7.95	C-3	SDS	2	3/8	0	1 1/16	0	5.5	2 3V 800 SDS	D-3	SDS	2	3/16	3/16	1 1/16	1 1/16	7.0		
1 3V 1060 SDS	10.60	10.55	C-3	SDS	2	3/8	0	1 1/16	0	8.0	2 3V 1060 SK	C-3	SK	2 3/16	7/16	1/4	1 1/16	1 1/16	10.0		
1 3V 1400 SK	14.00	13.95	C-3	SK	2 3/16	1 1/16	0	1 1/16	0	13.5	2 3V 1400 SK	C-3	SK	2 3/16	7/16	1/4	1 1/16	1 1/16	16.0		
1 3V 1900 SK	19.00	18.95	C-3	SK	2 3/16	1 1/16	0	1 1/16	0	17.0	2 3V 1900 SK	C-3	SK	2 3/16	7/16	1/4	1 1/16	1 1/16	25.0		
	25.00	24.95									2 3V 2500 SF	C-3	SF	2 15/16	7/16	1/4	2 1/16	1 1/16	28.0		

NOTE: Dimensions in inches, weight in pounds. Weights do not include bushings. See page B-3 and B-4 for additional bushing dimensions.

\* F = 3/16" for 1 3V 800 SDS and 1 3V 1060 SDS, F = 1/8" for 1 3V 1400 SK and 1 3V 1900 SK

☆ E and M dimensions are nominal and will vary depending on shaft tolerances. Type E sheaves are drilled for reverse mounting only.

# 3V Hi-Cap Wedge Stock QD Sheaves

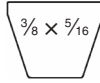

3V

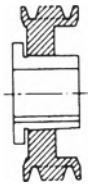

1 = SOLID

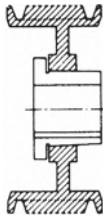

2 = WEB

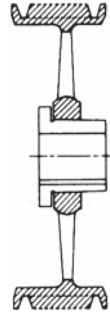

3 = ARM/SPOKE



Let *Martin* quote your made to order and large quantity requirements.

## QD Sheaves — 3V

3 Groove F = 1½											4 Groove F = 1 <sup>29</sup> / <sub>32</sub>									
Part Number	OD	PD 3V Belt	Type	Bush	Bush Max. Bore	E ☆	K	L Length Thru Bore	M ☆	Wt. Less Bush	Part Number	Type	Bush	Bush Max. Bore	E ☆	K	L Length Thru Bore	M ☆	Wt. Less Bush	
																				3 3V 250 JA
3 3V 265 JA	2.65	2.60	D-1	JA	1¼	⅝	⅞	1⅛	15/16	1.8	4 3V 280 JA	D-1	JA	1¼	⅝	⅝	1⅛	17/32	1.6	
3 3V 280 JA	2.80	2.75	D-1	JA	1¼	⅝	⅞	1⅛	15/16	2.0	4 3V 300 SH	E-1	SH	1⅛	1 <sup>15</sup> / <sub>32</sub>	⅝	1⅛	7/8	1.9	
3 3V 300 SH	3.00	2.95	E-1	SH	1⅛	1⅛	0	1⅛	⅝	2.2	4 3V 315 SH	E-1	SH	1⅛	1 <sup>15</sup> / <sub>32</sub>	⅝	1⅛	7/8	2.2	
3 3V 315 SH	3.15	3.10	E-1	SH	1⅛	1⅛	⅝	1⅛	⅝	2.5	4 3V 335 SH	D-1	SH	1⅛	⅞	⅝	1⅛	17/32	2.5	
3 3V 335 SH	3.35	3.30	D-1	SH	1⅛	⅞	⅞	1⅛	⅝	2.8	4 3V 365 SH	D-1	SH	1⅛	⅞	⅝	1⅛	17/32	2.8	
3 3V 365 SH	3.65	3.60	D-1	SH	1⅛	⅞	⅞	1⅛	⅝	3.0	4 3V 412 SH	A-1	SH	1⅛	¼	1⅞	1⅛	11/32	3.2	
3 3V 412 SH	4.12	4.07	A-1	SH	1⅛	⅞	1⅞	1⅛	⅝	3.3	4 3V 450 SDS	A-1	SDS	2	⅞	1⅞	1⅛	11/32	3.5	
3 3V 450 SDS	4.50	4.45	A-1	SDS	2	⅞	1⅞	1⅛	⅝	3.5	4 3V 475 SDS	A-1	SDS	2	⅞	1⅞	1⅛	11/32	4.0	
3 3V 475 SDS	4.75	4.70	A-1	SDS	2	⅞	1⅞	1⅛	⅝	3.7	4 3V 500 SDS	A-1	SDS	2	⅞	1⅞	1⅛	11/32	4.5	
3 3V 500 SDS	5.00	4.95	A-1	SDS	2	⅞	1⅞	1⅛	⅝	4.0	4 3V 530 SDS	A-1	SDS	2	⅞	1⅞	1⅛	11/32	5.0	
3 3V 530 SDS	5.30	5.25	A-1	SDS	2	⅞	1⅞	1⅛	⅝	4.3	4 3V 560 SDS	A-1	SDS	2	⅞	1⅞	1⅛	11/32	5.7	
3 3V 560 SDS	5.60	5.55	A-1	SDS	2	⅞	1⅞	1⅛	⅝	4.9	4 3V 600 SK	D-1	SK	2⅞	⅞	⅝	1 <sup>15</sup> / <sub>16</sub>	7/8	7.5	
3 3V 600 SDS	6.00	5.95	A-1	SDS	2	⅞	1⅞	1⅛	⅝	5.9	4 3V 650 SK	A-1	SK	2⅞	⅞	⅝	1 <sup>15</sup> / <sub>16</sub>	7/8	8.0	
3 3V 650 SDS	6.50	6.45	A-3	SDS	2	⅞	1⅞	1⅛	⅝	6.3	4 3V 690 SK	A-1	SK	2⅞	⅞	⅝	1 <sup>15</sup> / <sub>16</sub>	7/8	10.0	
3 3V 690 SDS	6.90	6.85	A-3	SDS	2	⅞	1⅞	1⅛	⅝	6.8	4 3V 800 SK	D-2	SK	2⅞	⅞	⅝	1 <sup>15</sup> / <sub>16</sub>	7/8	12.0	
3 3V 800 SK	8.00	7.95	C-2	SK	2⅞	⅞	¼	1 <sup>15</sup> / <sub>16</sub>	0	10.6	4 3V 1060 SK	D-3	SK	2⅞	⅞	⅝	1 <sup>15</sup> / <sub>16</sub>	7/8	16.0	
3 3V 1060 SK	10.60	10.55	C-3	SK	2⅞	⅞	¼	1 <sup>15</sup> / <sub>16</sub>	0	12.0	4 3V 1400 SK	D-3	SK	2⅞	⅞	⅝	1 <sup>15</sup> / <sub>16</sub>	7/8	22.0	
3 3V 1400 SK	14.00	13.95	C-3	SK	2⅞	⅞	¼	1 <sup>15</sup> / <sub>16</sub>	0	20.0	4 3V 1900 SF	C-3	SF	2 <sup>15</sup> / <sub>16</sub>	⅞	⅝	2⅞	3/8	37.0	
3 3V 1900 SF	19.00	18.95	C-3	SF	2 <sup>15</sup> / <sub>16</sub>	⅞	¼	2⅞	⅞	33.0	4 3V 2500 SF	C-3	SF	2 <sup>15</sup> / <sub>16</sub>	⅞	⅝	2⅞	3/8	53.0	
3 3V 2500 SF	25.00	24.95	C-3	SF	2 <sup>15</sup> / <sub>16</sub>	⅞	¼	2⅞	⅞	45.0	4 3V 3350 E	C-3	E	3⅞	⅞	⅝	2⅞	11/32	80.0	
3 3V 3350 SF	33.50	33.45	C-3	SF	2 <sup>15</sup> / <sub>16</sub>	⅞	¼	2⅞	⅞	75.0										

NOTE: Dimensions in inches, weight in pounds. Weights do not include bushings. See page B-3 and B-4 for additional bushing dimensions.

☆ E and M dimensions are nominal and will vary depending on shaft tolerances. Type E sheaves are drilled for reverse mounting only.

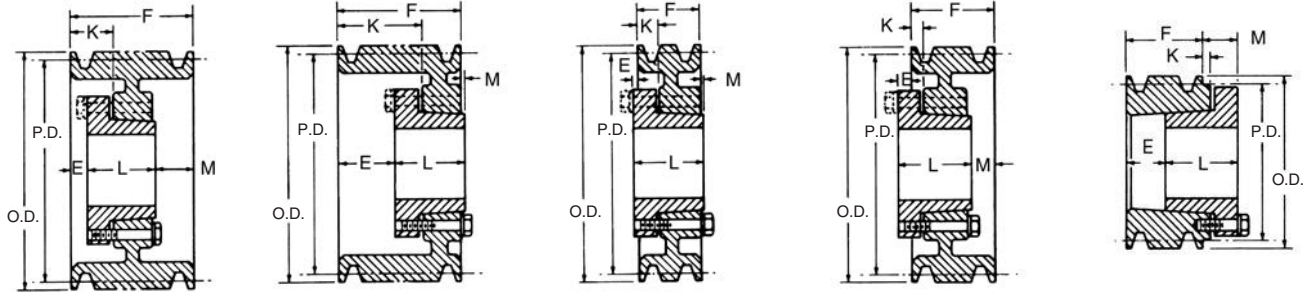

TYPE A

TYPE B

TYPE C

TYPE D

TYPE E

## QD Sheaves — 3V

5 Groove F = 2 <sup>5</sup> / <sub>16</sub>											6 Groove F = 2 <sup>23</sup> / <sub>32</sub>								
Part Number	OD	PD 3V Belt	Type	Bush	Bush Max. Bore	E ☆	K	L Length Thru Bore	M ☆	Wt. Less Bush	Part Number	Type	Bush	Bush Max. Bore	E ☆	K	L Length Thru Bore	M ☆	Wt. Less Bush
5 3V 475 SDS	4.75	4.70	A-2	SDS	2	3/16	13/16	1 1/8	3/4	4.5	6 3V 475 SK	D-1	SK	2 3/8	3/16	1/8	1 1/16	1 1/32	6.0
5 3V 500 SDS	5.00	4.95	A-2	SDS	2	3/16	13/16	1 1/8	3/4	5.3	6 3V 500 SK	D-1	SK	2 3/8	3/16	1/8	1 1/16	1 1/32	6.5
5 3V 530 SK	5.30	5.25	A-1	SK	2 1/2	1/4	1 1/16	1 1/16	1/2	5.8	6 3V 530 SK	A-1	SK	2 3/8	3/8	1 1/16	1 1/16	3/32	6.8
5 3V 560 SK	5.60	5.55	A-1	SK	2 1/2	1/4	1 1/16	1 1/16	1/2	7.0	6 3V 560 SK	A-1	SK	2 3/8	3/8	1 1/16	1 1/16	3/32	8.0
5 3V 600 SK	6.00	5.95	A-1	SK	2 1/2	1/4	1 1/16	1 1/16	1/2	8.3	6 3V 600 SK	A-1	SK	2 3/8	3/8	1 1/16	1 1/16	3/32	9.0
5 3V 650 SK	6.50	6.45	A-1	SK	2 1/2	1/4	1 1/16	1 1/16	1/2	9.0	6 3V 650 SK	A-2	SK	2 3/8	3/8	1 1/16	1 1/16	3/32	10.0
5 3V 690 SK	6.90	6.85	A-1	SK	2 1/2	1/4	1 1/16	1 1/16	1/2	12.0	6 3V 690 SK	A-2	SK	2 3/8	3/8	1 1/16	1 1/16	3/32	11.5
5 3V 800 SK	8.00	7.95	A-2	SK	2 1/2	1/4	1 1/16	1 1/16	1/2	13.0	6 3V 800 SK	A-2	SK	2 3/8	3/8	1 1/16	1 1/16	3/32	17.0
5 3V 1060 SK	10.60	10.55	A-3	SK	2 1/2	1/4	1 1/16	1 1/16	1/2	17.0	6 3V 1060 SF	A-2	SF	2 1/16	3/16	7/8	2 1/16	1 1/2	25.0
5 3V 1400 SF	14.00	13.95	A-3	SK	2 1/16	3/16	7/8	2 1/16	1/16	27.0	6 3V 1400 SF	A-3	SF	2 1/16	3/16	7/8	2 1/16	1 1/2	34.0
5 3V 1900 SF	19.00	18.95	A-3	SK	2 1/16	3/16	7/8	2 1/16	1/16	40.0	6 3V 1900 E	B-3	E	3 1/2	1/8	1	2 3/8	1/32	45.0
5 3V 2500 E	25.00	24.95	C-3	E	3 1/2	1/4	1	2 3/8	1/16	69.0	6 3V 2500 E	B-3	E	3 1/2	1/8	1	2 3/8	1/32	75.0
5 3V 3350 E	33.50	33.45	C-3	E	3 1/2	1/4	1	2 3/8	1/16	97.0	6 3V 3350 E	B-3	E	3 1/2	1/8	1	2 3/8	1/32	98.0

NOTE: Dimensions in inches, weight in pounds. Weights do not include bushings. See page B-3 and B-4 for additional bushing dimensions.  
 ☆ E and M dimensions are nominal and will vary depending on shaft tolerances. Type E sheaves are drilled for reverse mounting only.

## QD Sheaves — 3V

8 Groove F = 3 <sup>17</sup> / <sub>32</sub>											10 Groove F = 4 <sup>1</sup> / <sub>32</sub>								
Part Number	OD	PD 3V Belt	Type	Bush	Bush Max. Bore	E ☆	K	L Length Thru Bore	M ☆	Wt. Less Bush	Part Number	Type	Bush	Bush Max. Bore	E ☆	K	L Length Thru Bore	M ☆	Wt. Less Bush
8 3V 475 SK	4.75	4.70	D-1	SK	2 3/8	3/16	1/8	1 1/16	2 3/32	6.0	10 3V 475 SK	D-1	SK	2 3/8	3/16	1/8	1 1/16	2 3/32	7.0
8 3V 500 SK	5.00	4.95	D-1	SK	2 3/8	3/16	1/8	1 1/16	2 3/32	6.9	10 3V 500 SK	D-1	SK	2 3/8	3/16	1/8	1 1/16	2 3/32	8.6
8 3V 530 SK	5.30	5.25	A-1	SK	2 3/8	3/8	1 1/16	1 1/16	3/32	7.8	10 3V 530 SK	A-1	SK	2 3/8	3/4	1 1/16	1 1/16	1 2/32	9.0
8 3V 560 SK	5.60	5.55	A-1	SK	2 3/8	3/8	1 1/16	1 1/16	3/32	9.0	10 3V 560 SK	A-1	SK	2 3/8	3/4	1 1/16	1 1/16	1 2/32	10.0
8 3V 600 SK	6.00	5.95	A-1	SK	2 3/8	3/8	1 1/16	1 1/16	3/32	10.0	10 3V 600 SK	A-1	SK	2 3/8	3/4	1 1/16	1 1/16	1 2/32	11.0
8 3V 650 SK	6.50	6.45	A-2	SK	2 3/8	3/8	1 1/16	1 1/16	3/32	12.9	10 3V 650 SK	A-2	SK	2 3/8	3/4	1 1/16	1 1/16	1 2/32	14.0
8 3V 690 SK	6.90	6.85	A-2	SK	2 3/8	3/8	1 1/16	1 1/16	3/32	14.0	10 3V 690 SK	A-2	SK	2 3/8	3/4	1 1/16	1 1/16	1 2/32	16.0
8 3V 800 SF	8.00	7.95	A-1	SF	2 1/16	7/16	1 1/8	2 1/16	1 1/32	20.0	10 3V 800 SF	A-1	SF	2 1/16	13/16	1 1/2	2 1/16	1 1/2	22.0
8 3V 1060 SF	10.60	10.55	A-2	SF	2 1/16	7/16	1 1/8	2 1/16	1 1/32	28.0	10 3V 1060 E	A-2	E	3 1/2	3/8	1 1/4	2 3/8	1 1/32	33.0
8 3V 1400 E	14.00	13.95	A-3	E	3 1/2	3/8	1 1/4	2 3/8	1 1/32	40.0	10 3V 1400 E	A-3	E	3 1/2	3/8	1 1/4	2 3/8	1 1/32	43.0
8 3V 1900 E	19.00	18.95	A-3	E	3 1/2	3/8	1 1/4	2 3/8	1 1/32	62.0	10 3V 1900 E	A-3	E	3 1/2	3/8	1 1/4	2 3/8	1 1/32	66.0
8 3V 2500 E	25.00	24.95	A-3	E	3 1/2	3/8	1 1/4	2 3/8	1 1/32	87.0	10 3V 2500 F	A-3	F	3 1/16	3/16	1 3/8	3 3/8	1 3/32	98.0
8 3V 3350 F	33.50	33.45	B-3	F	3 1/16	1/16	1 1/8	3 3/8	3/32	152.0	10 3V 3350 F	A-3	F	3 1/16	3/16	1 3/8	3 3/8	1 3/32	178.0

NOTE: Dimensions in inches, weight in pounds. Weights do not include bushings. See page B-3 and B-4 for additional bushing dimensions.  
 ☆ E and M dimensions are nominal and will vary depending on shaft tolerances. Type E sheaves are drilled for reverse mounting only.

# 5V Hi-Cap Wedge Stock QD Sheaves

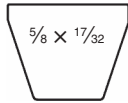

5V

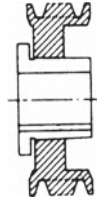

1 = SOLID

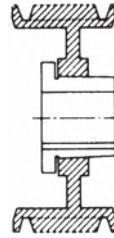

2 = WEB

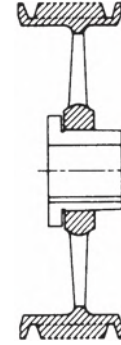

3 = ARM/SPOKE

## QD Sheaves — 5V

2 Groove F = 1 <sup>11</sup> / <sub>16</sub>										3 Groove F = 2 <sup>3</sup> / <sub>8</sub>									
Part Number	OD	PD	Type	Bush	Bush Max. Bore	E ☆	K	L Length Thru Bore	M ☆	Wt. Less Bush	Part Number	Type	Bush	Bush Max. Bore	E ☆	K	L Length Thru Bore	M ☆	Wt. Less Bush
		5V Belt																	
2 5V 440 SH	4.40	4.30	A-1	SH	1 <sup>11</sup> / <sub>16</sub>	<sup>5</sup> / <sub>16</sub>	<sup>7</sup> / <sub>8</sub>	1 <sup>1</sup> / <sub>16</sub>	<sup>1</sup> / <sub>16</sub>	4.0	3 5V 440 SDS	E-1	SDS	2	1 <sup>1</sup> / <sub>16</sub>	0	1 <sup>3</sup> / <sub>8</sub>	<sup>5</sup> / <sub>8</sub>	5.5
2 5V 465 SDS	4.65	4.55	E-1	SDS	2	<sup>1</sup> / <sub>16</sub>	0	1 <sup>1</sup> / <sub>16</sub>	<sup>1</sup> / <sub>16</sub>	4.5	3 5V 465 SDS	E-1	SDS	2	1 <sup>1</sup> / <sub>16</sub>	0	1 <sup>1</sup> / <sub>16</sub>	<sup>1</sup> / <sub>16</sub>	6.5
2 5V 490 SDS	4.90	4.80	A-1	SDS	2	<sup>1</sup> / <sub>16</sub>	<sup>1</sup> / <sub>16</sub>	1 <sup>1</sup> / <sub>16</sub>	<sup>1</sup> / <sub>4</sub>	5.0	3 5V 490 SDS	A-1	SDS	2	<sup>7</sup> / <sub>16</sub>	1 <sup>1</sup> / <sub>16</sub>	1 <sup>1</sup> / <sub>16</sub>	<sup>1</sup> / <sub>16</sub>	7.0
2 5V 520 SDS	5.20	5.10	A-1	SDS	2	<sup>1</sup> / <sub>16</sub>	<sup>1</sup> / <sub>16</sub>	1 <sup>1</sup> / <sub>16</sub>	<sup>1</sup> / <sub>4</sub>	5.5	3 5V 520 SDS	A-1	SDS	2	<sup>7</sup> / <sub>16</sub>	1 <sup>1</sup> / <sub>16</sub>	1 <sup>1</sup> / <sub>16</sub>	<sup>1</sup> / <sub>16</sub>	7.5
2 5V 550 SDS	5.50	5.40	A-1	SDS	2	<sup>1</sup> / <sub>16</sub>	<sup>1</sup> / <sub>16</sub>	1 <sup>1</sup> / <sub>16</sub>	<sup>1</sup> / <sub>4</sub>	6.0	3 5V 550 SDS	A-1	SDS	2	<sup>7</sup> / <sub>16</sub>	1 <sup>1</sup> / <sub>16</sub>	1 <sup>1</sup> / <sub>16</sub>	<sup>1</sup> / <sub>16</sub>	8.0
2 5V 590 SDS	5.90	5.80	A-1	SDS	2	<sup>1</sup> / <sub>16</sub>	<sup>1</sup> / <sub>16</sub>	1 <sup>1</sup> / <sub>16</sub>	<sup>1</sup> / <sub>4</sub>	7.0	3 5V 590 SDS	A-1	SDS	2	<sup>7</sup> / <sub>16</sub>	1 <sup>1</sup> / <sub>16</sub>	1 <sup>1</sup> / <sub>16</sub>	<sup>1</sup> / <sub>16</sub>	8.5
2 5V 630 SK	6.30	6.20	C-1	SK	2 <sup>5</sup> / <sub>8</sub>	<sup>1</sup> / <sub>4</sub>	<sup>7</sup> / <sub>16</sub>	1 <sup>1</sup> / <sub>16</sub>	0	8.0	3 5V 630 SK	A-1	SK	2 <sup>5</sup> / <sub>8</sub>	<sup>1</sup> / <sub>16</sub>	1 <sup>1</sup> / <sub>16</sub>	1 <sup>1</sup> / <sub>16</sub>	<sup>1</sup> / <sub>16</sub>	11.0
2 5V 670 SK	6.70	6.60	C-1	SK	2 <sup>5</sup> / <sub>8</sub>	<sup>1</sup> / <sub>4</sub>	<sup>7</sup> / <sub>16</sub>	1 <sup>1</sup> / <sub>16</sub>	0	10.0	3 5V 670 SK	A-1	SK	2 <sup>5</sup> / <sub>8</sub>	<sup>1</sup> / <sub>16</sub>	1 <sup>1</sup> / <sub>16</sub>	1 <sup>1</sup> / <sub>16</sub>	<sup>1</sup> / <sub>16</sub>	11.5
2 5V 710 SK	7.10	7.00	C-1	SK	2 <sup>5</sup> / <sub>8</sub>	<sup>1</sup> / <sub>4</sub>	<sup>7</sup> / <sub>16</sub>	1 <sup>1</sup> / <sub>16</sub>	0	11.0	3 5V 710 SF	A-1	SF	2 <sup>5</sup> / <sub>8</sub>	<sup>5</sup> / <sub>16</sub>	1	2 <sup>1</sup> / <sub>16</sub>	0	13.0
2 5V 750 SK	7.50	7.40	C-1	SK	2 <sup>5</sup> / <sub>8</sub>	<sup>1</sup> / <sub>4</sub>	<sup>7</sup> / <sub>16</sub>	1 <sup>1</sup> / <sub>16</sub>	0	13.0	3 5V 750 SF	A-1	SF	2 <sup>5</sup> / <sub>8</sub>	<sup>5</sup> / <sub>16</sub>	1	2 <sup>1</sup> / <sub>16</sub>	0	14.0
2 5V 800 SK	8.00	7.90	C-1	SK	2 <sup>5</sup> / <sub>8</sub>	<sup>1</sup> / <sub>4</sub>	<sup>7</sup> / <sub>16</sub>	1 <sup>1</sup> / <sub>16</sub>	0	14.0	3 5V 800 SF	A-1	SF	2 <sup>5</sup> / <sub>8</sub>	<sup>5</sup> / <sub>16</sub>	1	2 <sup>1</sup> / <sub>16</sub>	0	15.0
2 5V 850 SK	8.50	8.40	C-1	SK	2 <sup>5</sup> / <sub>8</sub>	<sup>1</sup> / <sub>4</sub>	<sup>7</sup> / <sub>16</sub>	1 <sup>1</sup> / <sub>16</sub>	0	15.0	3 5V 850 SF	A-1	SF	2 <sup>5</sup> / <sub>8</sub>	<sup>5</sup> / <sub>16</sub>	1	2 <sup>1</sup> / <sub>16</sub>	0	16.0
2 5V 900 SK	9.00	8.90	C-2	SK	2 <sup>5</sup> / <sub>8</sub>	<sup>1</sup> / <sub>4</sub>	<sup>7</sup> / <sub>16</sub>	1 <sup>1</sup> / <sub>16</sub>	0	16.0	3 5V 900 SF	A-2	SF	2 <sup>5</sup> / <sub>8</sub>	<sup>5</sup> / <sub>16</sub>	1	2 <sup>1</sup> / <sub>16</sub>	0	17.0
2 5V 925 SK	9.25	9.15	C-2	SK	2 <sup>5</sup> / <sub>8</sub>	<sup>1</sup> / <sub>4</sub>	<sup>7</sup> / <sub>16</sub>	1 <sup>1</sup> / <sub>16</sub>	0	16.5	3 5V 925 SF	A-2	SF	2 <sup>5</sup> / <sub>8</sub>	<sup>5</sup> / <sub>16</sub>	1	2 <sup>1</sup> / <sub>16</sub>	0	18.0
2 5V 975 SK	9.75	9.65	C-3	SK	2 <sup>5</sup> / <sub>8</sub>	<sup>1</sup> / <sub>4</sub>	<sup>7</sup> / <sub>16</sub>	1 <sup>1</sup> / <sub>16</sub>	0	17.0	3 5V 975 SF	A-2	SF	2 <sup>5</sup> / <sub>8</sub>	<sup>5</sup> / <sub>16</sub>	1	2 <sup>1</sup> / <sub>16</sub>	0	19.0
2 5V 1030 SK	10.30	10.20	C-3	SK	2 <sup>5</sup> / <sub>8</sub>	<sup>1</sup> / <sub>4</sub>	<sup>7</sup> / <sub>16</sub>	1 <sup>1</sup> / <sub>16</sub>	0	18.0	3 5V 1030 SF	A-2	SF	2 <sup>5</sup> / <sub>8</sub>	<sup>5</sup> / <sub>16</sub>	1	2 <sup>1</sup> / <sub>16</sub>	0	22.0
2 5V 1090 SK	10.90	10.80	C-3	SK	2 <sup>5</sup> / <sub>8</sub>	<sup>1</sup> / <sub>4</sub>	<sup>7</sup> / <sub>16</sub>	1 <sup>1</sup> / <sub>16</sub>	0	19.0	3 5V 1090 SF	A-2	SF	2 <sup>5</sup> / <sub>8</sub>	<sup>5</sup> / <sub>16</sub>	1	2 <sup>1</sup> / <sub>16</sub>	0	25.0
2 5V 1130 SK	11.30	11.20	C-3	SK	2 <sup>5</sup> / <sub>8</sub>	<sup>1</sup> / <sub>4</sub>	<sup>7</sup> / <sub>16</sub>	1 <sup>1</sup> / <sub>16</sub>	0	19.5	3 5V 1130 SF	A-2	SF	2 <sup>5</sup> / <sub>8</sub>	<sup>5</sup> / <sub>16</sub>	1	2 <sup>1</sup> / <sub>16</sub>	0	25.0
2 5V 1180 SK	11.80	11.70	C-3	SK	2 <sup>5</sup> / <sub>8</sub>	<sup>1</sup> / <sub>4</sub>	<sup>7</sup> / <sub>16</sub>	1 <sup>1</sup> / <sub>16</sub>	0	20.0	3 5V 1180 SF	A-2	SF	2 <sup>5</sup> / <sub>8</sub>	<sup>5</sup> / <sub>16</sub>	1	2 <sup>1</sup> / <sub>16</sub>	0	29.0
2 5V 1250 SF	12.50	12.40	C-3	SF	2 <sup>5</sup> / <sub>8</sub>	<sup>1</sup> / <sub>4</sub>	<sup>7</sup> / <sub>16</sub>	2 <sup>1</sup> / <sub>16</sub>	<sup>1</sup> / <sub>8</sub>	25.0	3 5V 1250 E	C-2	E	3 <sup>1</sup> / <sub>2</sub>	<sup>1</sup> / <sub>8</sub>	<sup>3</sup> / <sub>4</sub>	2 <sup>1</sup> / <sub>16</sub>	<sup>1</sup> / <sub>8</sub>	32.0
2 5V 1320 SF	13.20	13.10	C-3	SF	2 <sup>5</sup> / <sub>8</sub>	<sup>1</sup> / <sub>4</sub>	<sup>7</sup> / <sub>16</sub>	2 <sup>1</sup> / <sub>16</sub>	<sup>1</sup> / <sub>8</sub>	27.0	3 5V 1320 E	C-3	E	3 <sup>1</sup> / <sub>2</sub>	<sup>1</sup> / <sub>8</sub>	<sup>3</sup> / <sub>4</sub>	2 <sup>1</sup> / <sub>16</sub>	<sup>1</sup> / <sub>8</sub>	38.0
2 5V 1400 SF	14.00	13.90	C-3	SF	2 <sup>5</sup> / <sub>8</sub>	<sup>1</sup> / <sub>4</sub>	<sup>7</sup> / <sub>16</sub>	2 <sup>1</sup> / <sub>16</sub>	<sup>1</sup> / <sub>8</sub>	28.0	3 5V 1400 E	C-3	E	3 <sup>1</sup> / <sub>2</sub>	<sup>1</sup> / <sub>8</sub>	<sup>3</sup> / <sub>4</sub>	2 <sup>1</sup> / <sub>16</sub>	<sup>1</sup> / <sub>8</sub>	43.0
2 5V 1500 SF	15.00	14.90	C-3	SF	2 <sup>5</sup> / <sub>8</sub>	<sup>1</sup> / <sub>4</sub>	<sup>7</sup> / <sub>16</sub>	2 <sup>1</sup> / <sub>16</sub>	<sup>1</sup> / <sub>8</sub>	30.0	3 5V 1500 E	C-3	E	3 <sup>1</sup> / <sub>2</sub>	<sup>1</sup> / <sub>8</sub>	<sup>3</sup> / <sub>4</sub>	2 <sup>1</sup> / <sub>16</sub>	<sup>1</sup> / <sub>8</sub>	44.0
2 5V 1600 SF	16.00	15.90	C-3	SF	2 <sup>5</sup> / <sub>8</sub>	<sup>1</sup> / <sub>4</sub>	<sup>7</sup> / <sub>16</sub>	2 <sup>1</sup> / <sub>16</sub>	<sup>1</sup> / <sub>8</sub>	34.0	3 5V 1600 E	C-3	E	3 <sup>1</sup> / <sub>2</sub>	<sup>1</sup> / <sub>8</sub>	<sup>3</sup> / <sub>4</sub>	2 <sup>1</sup> / <sub>16</sub>	<sup>1</sup> / <sub>8</sub>	46.0
2 5V 1870 SF	18.70	18.60	C-3	SF	2 <sup>5</sup> / <sub>8</sub>	<sup>1</sup> / <sub>4</sub>	<sup>7</sup> / <sub>16</sub>	2 <sup>1</sup> / <sub>16</sub>	<sup>1</sup> / <sub>8</sub>	49.0	3 5V 1870 E	C-3	E	3 <sup>1</sup> / <sub>2</sub>	<sup>1</sup> / <sub>8</sub>	<sup>3</sup> / <sub>4</sub>	2 <sup>1</sup> / <sub>16</sub>	<sup>1</sup> / <sub>8</sub>	60.0
2 5V 2120 SF	21.20	21.10	C-3	SF	2 <sup>5</sup> / <sub>8</sub>	<sup>1</sup> / <sub>4</sub>	<sup>7</sup> / <sub>16</sub>	2 <sup>1</sup> / <sub>16</sub>	<sup>1</sup> / <sub>8</sub>	50.0	3 5V 2120 E	C-3	E	3 <sup>1</sup> / <sub>2</sub>	<sup>1</sup> / <sub>8</sub>	<sup>3</sup> / <sub>4</sub>	2 <sup>1</sup> / <sub>16</sub>	<sup>1</sup> / <sub>8</sub>	68.0
2 5V 2360 E	23.60	23.50	C-3	E	3 <sup>1</sup> / <sub>2</sub>	<sup>3</sup> / <sub>8</sub>	<sup>1</sup> / <sub>4</sub>	2 <sup>1</sup> / <sub>16</sub>	<sup>1</sup> / <sub>16</sub>	72.0	3 5V 2360 E	C-3	E	3 <sup>1</sup> / <sub>2</sub>	<sup>1</sup> / <sub>8</sub>	<sup>3</sup> / <sub>4</sub>	2 <sup>1</sup> / <sub>16</sub>	<sup>1</sup> / <sub>8</sub>	80.0
2 5V 2800 E	28.00	27.90	C-3	E	3 <sup>1</sup> / <sub>2</sub>	<sup>3</sup> / <sub>8</sub>	<sup>1</sup> / <sub>4</sub>	2 <sup>1</sup> / <sub>16</sub>	<sup>1</sup> / <sub>16</sub>	80.0	3 5V 2800 E	C-3	E	3 <sup>1</sup> / <sub>2</sub>	<sup>1</sup> / <sub>8</sub>	<sup>3</sup> / <sub>4</sub>	2 <sup>1</sup> / <sub>16</sub>	<sup>1</sup> / <sub>8</sub>	92.0
	31.50	31.40									3 5V 3150 F	C-3	F	3 <sup>1</sup> / <sub>2</sub>	<sup>7</sup> / <sub>16</sub>	<sup>1</sup> / <sub>8</sub>	3 <sup>1</sup> / <sub>16</sub>	<sup>1</sup> / <sub>16</sub>	136.0
	37.50	37.40									3 5V 3750 F	C-3	F	3 <sup>1</sup> / <sub>2</sub>	<sup>7</sup> / <sub>16</sub>	<sup>1</sup> / <sub>8</sub>	3 <sup>1</sup> / <sub>16</sub>	<sup>1</sup> / <sub>16</sub>	156.0
	50.00	49.90									3 5V 5000 F	C-3	F	3 <sup>1</sup> / <sub>2</sub>	<sup>7</sup> / <sub>16</sub>	<sup>1</sup> / <sub>8</sub>	3 <sup>1</sup> / <sub>16</sub>	<sup>1</sup> / <sub>16</sub>	210.0

NOTE: Dimensions in inches, weight in pounds. Weights do not include bushings. See page B-3 and B-4 for additional bushing dimensions.

☆ E and M dimensions are nominal and will vary depending on shaft tolerances. Type E sheaves are drilled for reverse mounting only.

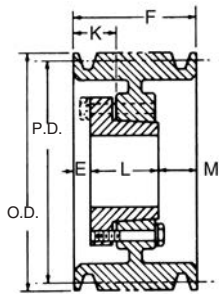

TYPE A

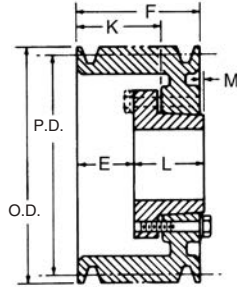

TYPE B

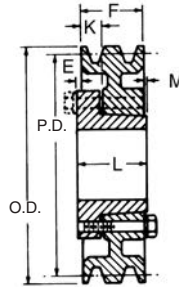

TYPE C

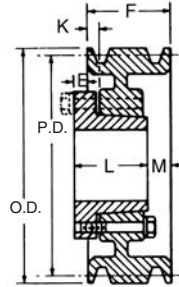

TYPE D

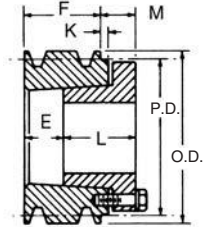

TYPE E

## QD Sheaves — 5V

4 Groove F = 3 1/16											5 Groove F = 3 3/4								
Part Number	OD	PD 5V Belt	Type	Bush	Bush Max. Bore	E ☆	K	L Length Thru Bore	M ☆	Wt. Less Bush	Part Number	Type	Bush	Bush Max. Bore	E ☆	K	L Length Thru Bore	M ☆	Wt. Less Bush
4 5V 465 SD	4.65	4.55	E-1	SD	2	1 1/16	0	1 13/16	5/8	6.0	5 5V 465 SD	E-1	SD	2	2 1/16	1 1/16	1 1/16	5/8	7.0
4 5V 490 SD	4.90	4.80	A-1	SD	2	1 1/16	1 1/16	1 13/16	5/8	7.0	5 5V 490 SD	A-1	SD	2	1 1/16	1 1/16	1 1/16	1 1/4	8.0
4 5V 520 SD	5.20	5.10	A-1	SD	2	1 1/16	1 1/16	1 13/16	5/8	8.0	5 5V 520 SD	A-1	SD	2	1 1/16	1 1/16	1 1/16	1 1/4	9.0
4 5V 550 SD	5.50	5.40	A-1	SD	2	1 1/16	1 1/16	1 13/16	5/8	9.0	5 5V 550 SD	A-1	SD	2	1 1/16	1 1/16	1 1/16	1 1/4	10.0
4 5V 590 SD	5.90	5.80	A-1	SD	2	1 1/16	1 1/16	1 13/16	5/8	10.8	5 5V 590 SK	A-1	SK	2 1/2	5/8	1 1/16	1 1/16	1 1/16	11.0
4 5V 630 SK	6.30	6.20	A-1	SK	2 1/2	5/8	1 1/16	1 13/16	1/2	12.0	5 5V 630 SK	A-1	SK	2 1/2	5/8	1 1/16	1 1/16	1 1/16	12.0
4 5V 670 SK	6.70	6.60	A-1	SK	2 1/2	5/8	1 1/16	1 13/16	1/2	14.0	5 5V 670 SF	A-1	SF	2 15/16	5/8	1 1/16	2 1/16	1 1/16	13.0
4 5V 710 SF	7.10	7.00	A-1	SF	2 15/16	5/8	1 1/16	2 1/16	5/8	15.0	5 5V 710 SF	A-1	SF	2 15/16	1 1/16	1 1/16	2 1/16	1	14.0
4 5V 750 SF	7.50	7.40	A-1	SF	2 15/16	5/8	1 1/16	2 1/16	5/8	16.0	5 5V 750 SF	A-1	SF	2 15/16	1 1/16	1 1/16	2 1/16	1	16.0
4 5V 800 E	8.00	7.90	B-1	E	3 1/2	7/8	1 1/16	2 1/8	1/2	19.0	5 5V 800 E	A-1	E	3 1/2	7/8	1 1/16	2 1/8	1/2	19.0
4 5V 850 E	8.50	8.40	B-1	E	3 1/2	7/8	1 1/16	2 1/8	1/2	23.0	5 5V 850 E	A-1	E	3 1/2	7/8	1 1/16	2 1/8	1/2	22.0
4 5V 900 E	9.00	8.90	B-1	E	3 1/2	7/8	1 1/16	2 1/8	1/2	25.0	5 5V 900 E	A-1	E	3 1/2	7/8	1 1/16	2 1/8	1/2	26.0
4 5V 925 E	9.25	9.15	B-1	E	3 1/2	7/8	1 1/16	2 1/8	1/2	26.0	5 5V 925 E	A-1	E	3 1/2	7/8	1 1/16	2 1/8	1/2	28.0
4 5V 975 E	9.75	9.65	B-1	E	3 1/2	7/8	1 1/16	2 1/8	1/2	28.0	5 5V 975 E	A-1	E	3 1/2	7/8	1 1/16	2 1/8	1/2	30.0
4 5V 1030 E	10.30	10.20	B-1	E	3 1/2	7/8	1 1/16	2 1/8	1/2	30.0	5 5V 1030 E	A-1	E	3 1/2	7/8	1 1/16	2 1/8	1/2	33.0
4 5V 1090 E	10.90	10.80	B-2	E	3 1/2	7/8	1 1/16	2 1/8	1/2	39.0	5 5V 1090 E	A-1	E	3 1/2	7/8	1 1/16	2 1/8	1/2	41.0
4 5V 1130 E	11.30	11.20	B-2	E	3 1/2	7/8	1 1/16	2 1/8	1/2	40.0	5 5V 1130 E	A-1	E	3 1/2	7/8	1 1/16	2 1/8	1/2	42.0
4 5V 1180 E	11.80	11.70	B-2	E	3 1/2	7/8	1 1/16	2 1/8	1/2	41.0	5 5V 1180 E	A-1	E	3 1/2	7/8	1 1/16	2 1/8	1/2	44.0
4 5V 1250 E	12.50	12.40	B-3	E	3 1/2	7/8	1 1/16	2 1/8	1/2	43.0	5 5V 1250 E	A-3	E	3 1/2	7/8	1 1/16	2 1/8	1/2	45.0
4 5V 1320 E	13.20	13.10	B-3	E	3 1/2	7/8	1 1/16	2 1/8	1/2	45.0	5 5V 1320 E	A-3	E	3 1/2	7/8	1 1/16	2 1/8	1/2	46.0
4 5V 1400 E	14.00	13.90	B-3	E	3 1/2	7/8	1 1/16	2 1/8	1/2	46.0	5 5V 1400 E	A-3	E	3 1/2	7/8	1 1/16	2 1/8	1/2	47.0
4 5V 1500 E	15.00	14.90	B-3	E	3 1/2	7/8	1 1/16	2 1/8	1/2	47.0	5 5V 1500 E	A-3	E	3 1/2	7/8	1 1/16	2 1/8	1/2	53.0
4 5V 1600 E	16.00	15.90	B-3	E	3 1/2	7/8	1 1/16	2 1/8	1/2	49.0	5 5V 1600 E	A-3	E	3 1/2	7/8	1 1/16	2 1/8	1/2	56.0
4 5V 1870 E	18.70	18.60	A-3	E	3 1/2	7/8	1 1/4	2 1/8	1/2	71.0	5 5V 1870 F	B-3	F	3 15/16	7/8	1 1/16	3 1/8	3/8	96.0
4 5V 2120 E	21.20	21.10	A-3	E	3 1/2	7/8	1 1/4	2 1/8	1/2	72.0	5 5V 2120 F	B-3	F	3 15/16	7/8	1 1/16	3 1/8	3/8	98.0
4 5V 2360 F	23.60	23.50	C-3	F	3 15/16	7/8	3/8	3 1/8	7/16	111.0	5 5V 2360 F	B-3	F	3 15/16	7/8	1 1/16	3 1/8	3/8	120.0
4 5V 2800 F	28.00	27.90	C-3	F	3 15/16	7/8	3/8	3 1/8	7/16	118.0	5 5V 2800 F	B-3	F	3 15/16	7/8	1 1/16	3 1/8	3/8	135.0
4 5V 3150 F	31.50	31.40	C-3	F	3 15/16	7/8	3/8	3 1/8	7/16	146.7	5 5V 3150 J	C-3	J	4 1/2	3/8	1	4 1/2	3/8	188.0
4 5V 3750 F	37.50	37.40	C-3	F	3 15/16	7/8	3/8	3 1/8	7/16	178.0	5 5V 3750 J	C-3	J	4 1/2	3/8	1	4 1/2	3/8	224.0
4 5V 5000 J	50.00	49.90	C-3	J	4 1/2	1/2	1 1/16	4 1/2	15/16	266.0	5 5V 5000 J	C-3	J	4 1/2	3/8	1	4 1/2	3/8	308.0

NOTE: Dimensions in inches, weight in pounds. Weights do not include bushings. See page B-3 and B-4 for additional bushing dimensions.  
 ☆ E and M dimensions are nominal and will vary depending on shaft tolerances. Type E sheaves are drilled for reverse mounting only.

# 5V Hi-Cap Wedge Stock QD Sheaves

# Martin

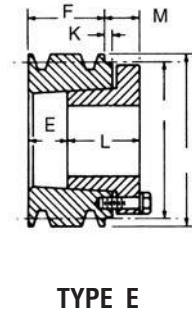
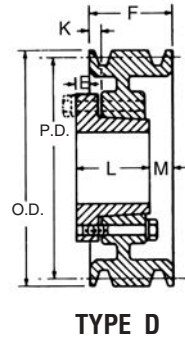
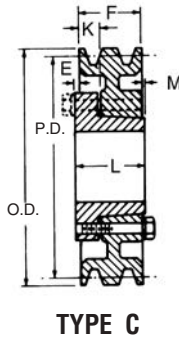
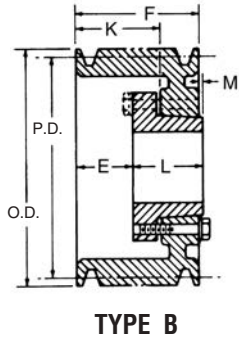
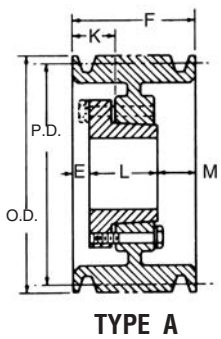

TYPE A

TYPE B

TYPE C

TYPE D

TYPE E

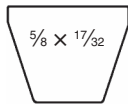

5V

QD Sheaves — 5V

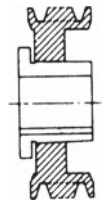

1 = SOLID

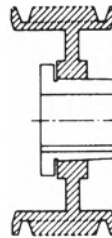

2 = WEB

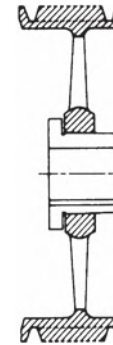

3 = ARM/SPOKE

6 Groove F = 4 <sup>7</sup> / <sub>16</sub>											7 Groove F = 5 <sup>1</sup> / <sub>8</sub>									
Part Number	OD	PD 5V Belt	Type	Bush	Bush Max. Bore	E *	K	L Length Thru Bore	M *	Wt. Less Bush	Part Number	Type	Bush	Bush Max. Bore	E *	K	L Length Thru Bore	M *	Wt. Less Bush	
6 5V 440 SD	4.40	4.30	E-1	SD	2	3 <sup>1</sup> / <sub>4</sub>	0	1 <sup>1</sup> / <sub>16</sub>	%	7.0										
6 5V 465 SD	4.65	4.55	E-1	SD	2	3 <sup>1</sup> / <sub>4</sub>	0	1 <sup>1</sup> / <sub>16</sub>	%	7.8										
6 5V 490 SD	4.90	4.80	A-1	SD	2	1 <sup>1</sup> / <sub>16</sub>	1 <sup>1</sup> / <sub>16</sub>	1 <sup>1</sup> / <sub>16</sub>	1 <sup>1</sup> / <sub>16</sub>	9.0										
6 5V 520 SD	5.20	5.10	A-1	SD	2	1 <sup>1</sup> / <sub>16</sub>	1 <sup>1</sup> / <sub>16</sub>	1 <sup>1</sup> / <sub>16</sub>	1 <sup>1</sup> / <sub>16</sub>	10.8										
6 5V 550 SD	5.50	5.40	A-1	SD	2	1 <sup>1</sup> / <sub>16</sub>	1 <sup>1</sup> / <sub>16</sub>	1 <sup>1</sup> / <sub>16</sub>	1 <sup>1</sup> / <sub>16</sub>	11.3										
6 5V 590 SK	5.90	5.80	A-1	SK	2 <sup>5</sup> / <sub>16</sub>	%	1 <sup>1</sup> / <sub>16</sub>	1 <sup>1</sup> / <sub>16</sub>	1 <sup>1</sup> / <sub>16</sub>	12.0										
6 5V 630 SK	6.30	6.20	A-1	SK	2 <sup>5</sup> / <sub>16</sub>	%	1 <sup>1</sup> / <sub>16</sub>	1 <sup>1</sup> / <sub>16</sub>	1 <sup>1</sup> / <sub>16</sub>	13.0										
6 5V 670 SF	6.70	6.60	A-1	SF	2 <sup>1</sup> / <sub>16</sub>	1 <sup>1</sup> / <sub>16</sub>	1 <sup>1</sup> / <sub>16</sub>	2 <sup>1</sup> / <sub>16</sub>	1 <sup>1</sup> / <sub>16</sub>	14.0										
6 5V 710 SF	7.10	7.00	A-1	SF	2 <sup>1</sup> / <sub>16</sub>	1 <sup>1</sup> / <sub>16</sub>	1 <sup>1</sup> / <sub>16</sub>	2 <sup>1</sup> / <sub>16</sub>	1 <sup>1</sup> / <sub>16</sub>	15.0	7 5V 710 SF	A-1	SF	2 <sup>1</sup> / <sub>16</sub>	1 <sup>1</sup> / <sub>16</sub>	1 <sup>1</sup> / <sub>16</sub>	2 <sup>1</sup> / <sub>16</sub>	2 <sup>1</sup> / <sub>16</sub>	17.0	
6 5V 750 SF	7.50	7.40	A-1	SF	2 <sup>1</sup> / <sub>16</sub>	1 <sup>1</sup> / <sub>16</sub>	1 <sup>1</sup> / <sub>16</sub>	2 <sup>1</sup> / <sub>16</sub>	1 <sup>1</sup> / <sub>16</sub>	17.0	7 5V 750 SF	A-1	SF	2 <sup>1</sup> / <sub>16</sub>	1 <sup>1</sup> / <sub>16</sub>	1 <sup>1</sup> / <sub>16</sub>	2 <sup>1</sup> / <sub>16</sub>	2 <sup>1</sup> / <sub>16</sub>	19.0	
6 5V 800 E	8.00	7.90	A-1	E	3 <sup>1</sup> / <sub>2</sub>	1 <sup>1</sup> / <sub>2</sub>	2	2 <sup>1</sup> / <sub>16</sub>	1 <sup>1</sup> / <sub>16</sub>	20.0	7 5V 800 E	A-1	E	3 <sup>1</sup> / <sub>2</sub>	1 <sup>1</sup> / <sub>2</sub>	2	2 <sup>1</sup> / <sub>16</sub>	1 <sup>1</sup> / <sub>16</sub>	22.0	
6 5V 850 E	8.50	8.40	A-1	E	3 <sup>1</sup> / <sub>2</sub>	1 <sup>1</sup> / <sub>2</sub>	2	2 <sup>1</sup> / <sub>16</sub>	1 <sup>1</sup> / <sub>16</sub>	25.0	7 5V 850 E	A-1	E	3 <sup>1</sup> / <sub>2</sub>	1 <sup>1</sup> / <sub>2</sub>	2	2 <sup>1</sup> / <sub>16</sub>	1 <sup>1</sup> / <sub>16</sub>	26.0	
6 5V 900 E	9.00	8.90	A-1	E	3 <sup>1</sup> / <sub>2</sub>	1 <sup>1</sup> / <sub>2</sub>	2	2 <sup>1</sup> / <sub>16</sub>	1 <sup>1</sup> / <sub>16</sub>	28.0	7 5V 900 E	A-1	E	3 <sup>1</sup> / <sub>2</sub>	1 <sup>1</sup> / <sub>2</sub>	2	2 <sup>1</sup> / <sub>16</sub>	1 <sup>1</sup> / <sub>16</sub>	29.0	
6 5V 925 E	9.25	9.15	A-1	E	3 <sup>1</sup> / <sub>2</sub>	1 <sup>1</sup> / <sub>2</sub>	2	2 <sup>1</sup> / <sub>16</sub>	1 <sup>1</sup> / <sub>16</sub>	29.0	7 5V 925 E	A-1	E	3 <sup>1</sup> / <sub>2</sub>	1 <sup>1</sup> / <sub>2</sub>	2	2 <sup>1</sup> / <sub>16</sub>	1 <sup>1</sup> / <sub>16</sub>	33.0	
6 5V 975 E	9.75	9.65	A-1	E	3 <sup>1</sup> / <sub>2</sub>	1 <sup>1</sup> / <sub>2</sub>	2	2 <sup>1</sup> / <sub>16</sub>	1 <sup>1</sup> / <sub>16</sub>	31.0	7 5V 975 E	A-1	E	3 <sup>1</sup> / <sub>2</sub>	1 <sup>1</sup> / <sub>2</sub>	2	2 <sup>1</sup> / <sub>16</sub>	1 <sup>1</sup> / <sub>16</sub>	37.0	
6 5V 1030 E	10.30	10.20	A-1	E	3 <sup>1</sup> / <sub>2</sub>	1 <sup>1</sup> / <sub>2</sub>	2	2 <sup>1</sup> / <sub>16</sub>	1 <sup>1</sup> / <sub>16</sub>	33.0	7 5V 1030 F	B-1	F	3 <sup>1</sup> / <sub>16</sub>	1 <sup>1</sup> / <sub>16</sub>	2 <sup>1</sup> / <sub>16</sub>	3 <sup>1</sup> / <sub>16</sub>	1 <sup>1</sup> / <sub>16</sub>	49.0	
6 5V 1090 E	10.90	10.80	A-1	E	3 <sup>1</sup> / <sub>2</sub>	1 <sup>1</sup> / <sub>2</sub>	2	2 <sup>1</sup> / <sub>16</sub>	1 <sup>1</sup> / <sub>16</sub>	38.0	7 5V 1090 F	B-1	F	3 <sup>1</sup> / <sub>16</sub>	1 <sup>1</sup> / <sub>16</sub>	2 <sup>1</sup> / <sub>16</sub>	3 <sup>1</sup> / <sub>16</sub>	1 <sup>1</sup> / <sub>16</sub>	56.0	
6 5V 1130 E	11.30	11.20	A-1	E	3 <sup>1</sup> / <sub>2</sub>	1 <sup>1</sup> / <sub>2</sub>	2	2 <sup>1</sup> / <sub>16</sub>	1 <sup>1</sup> / <sub>16</sub>	41.0	7 5V 1130 F	B-1	F	3 <sup>1</sup> / <sub>16</sub>	1 <sup>1</sup> / <sub>16</sub>	2 <sup>1</sup> / <sub>16</sub>	3 <sup>1</sup> / <sub>16</sub>	1 <sup>1</sup> / <sub>16</sub>	61.0	
6 5V 1180 E	11.80	11.70	A-1	E	3 <sup>1</sup> / <sub>2</sub>	1 <sup>1</sup> / <sub>2</sub>	2	2 <sup>1</sup> / <sub>16</sub>	1 <sup>1</sup> / <sub>16</sub>	43.0	7 5V 1180 F	B-2	F	3 <sup>1</sup> / <sub>16</sub>	1 <sup>1</sup> / <sub>16</sub>	2 <sup>1</sup> / <sub>16</sub>	3 <sup>1</sup> / <sub>16</sub>	1 <sup>1</sup> / <sub>16</sub>	56.0	
6 5V 1250 F	12.50	12.40	B-3	F	3 <sup>1</sup> / <sub>16</sub>	1 <sup>1</sup> / <sub>16</sub>	2 <sup>1</sup> / <sub>16</sub>	3 <sup>1</sup> / <sub>16</sub>	1 <sup>1</sup> / <sub>16</sub>	45.0	7 5V 1250 F	B-3	F	3 <sup>1</sup> / <sub>16</sub>	1 <sup>1</sup> / <sub>16</sub>	2 <sup>1</sup> / <sub>16</sub>	3 <sup>1</sup> / <sub>16</sub>	1 <sup>1</sup> / <sub>16</sub>	53.0	
6 5V 1320 F	13.20	13.10	B-3	F	3 <sup>1</sup> / <sub>16</sub>	1 <sup>1</sup> / <sub>16</sub>	2 <sup>1</sup> / <sub>16</sub>	3 <sup>1</sup> / <sub>16</sub>	1 <sup>1</sup> / <sub>16</sub>	48.0	7 5V 1320 F	B-3	F	3 <sup>1</sup> / <sub>16</sub>	1 <sup>1</sup> / <sub>16</sub>	2 <sup>1</sup> / <sub>16</sub>	3 <sup>1</sup> / <sub>16</sub>	1 <sup>1</sup> / <sub>16</sub>	52.0	
6 5V 1400 F	14.00	13.90	B-3	F	3 <sup>1</sup> / <sub>16</sub>	1 <sup>1</sup> / <sub>16</sub>	2 <sup>1</sup> / <sub>16</sub>	3 <sup>1</sup> / <sub>16</sub>	1 <sup>1</sup> / <sub>16</sub>	59.0	7 5V 1400 F	B-3	F	3 <sup>1</sup> / <sub>16</sub>	1 <sup>1</sup> / <sub>16</sub>	2 <sup>1</sup> / <sub>16</sub>	3 <sup>1</sup> / <sub>16</sub>	1 <sup>1</sup> / <sub>16</sub>	62.0	
6 5V 1500 F	15.00	14.90	B-3	F	3 <sup>1</sup> / <sub>16</sub>	1 <sup>1</sup> / <sub>16</sub>	2 <sup>1</sup> / <sub>16</sub>	3 <sup>1</sup> / <sub>16</sub>	1 <sup>1</sup> / <sub>16</sub>	64.0	7 5V 1500 F	B-3	F	3 <sup>1</sup> / <sub>16</sub>	1 <sup>1</sup> / <sub>16</sub>	2 <sup>1</sup> / <sub>16</sub>	3 <sup>1</sup> / <sub>16</sub>	1 <sup>1</sup> / <sub>16</sub>	67.0	
6 5V 1600 F	16.00	15.90	B-3	F	3 <sup>1</sup> / <sub>16</sub>	1 <sup>1</sup> / <sub>16</sub>	2 <sup>1</sup> / <sub>16</sub>	3 <sup>1</sup> / <sub>16</sub>	1 <sup>1</sup> / <sub>16</sub>	68.0	7 5V 1600 F	B-3	F	3 <sup>1</sup> / <sub>16</sub>	1 <sup>1</sup> / <sub>16</sub>	2 <sup>1</sup> / <sub>16</sub>	3 <sup>1</sup> / <sub>16</sub>	1 <sup>1</sup> / <sub>16</sub>	77.0	
6 5V 1870 F	18.70	18.60	A-3	F	3 <sup>1</sup> / <sub>16</sub>	1 <sup>1</sup> / <sub>16</sub>	2 <sup>1</sup> / <sub>16</sub>	3 <sup>1</sup> / <sub>16</sub>	1 <sup>1</sup> / <sub>16</sub>	83.8	7 5V 1870 F	A-3	F	3 <sup>1</sup> / <sub>16</sub>	1 <sup>1</sup> / <sub>16</sub>	2 <sup>1</sup> / <sub>16</sub>	3 <sup>1</sup> / <sub>16</sub>	1 <sup>1</sup> / <sub>16</sub>	99.0	
6 5V 2120 F	21.20	21.10	A-3	F	3 <sup>1</sup> / <sub>16</sub>	1 <sup>1</sup> / <sub>16</sub>	2 <sup>1</sup> / <sub>16</sub>	3 <sup>1</sup> / <sub>16</sub>	1 <sup>1</sup> / <sub>16</sub>	110.0	7 5V 2120 J	C-3	J	4 <sup>1</sup> / <sub>16</sub>	1 <sup>1</sup> / <sub>16</sub>	4 <sup>1</sup> / <sub>16</sub>	4 <sup>1</sup> / <sub>16</sub>	1 <sup>1</sup> / <sub>16</sub>	138.0	
6 5V 2360 J	23.60	23.50	B-3	J	4 <sup>1</sup> / <sub>16</sub>	1 <sup>1</sup> / <sub>16</sub>	2 <sup>1</sup> / <sub>16</sub>	3 <sup>1</sup> / <sub>16</sub>	1 <sup>1</sup> / <sub>16</sub>	148.0	7 5V 2360 J	C-3	J	4 <sup>1</sup> / <sub>16</sub>	1 <sup>1</sup> / <sub>16</sub>	4 <sup>1</sup> / <sub>16</sub>	4 <sup>1</sup> / <sub>16</sub>	1 <sup>1</sup> / <sub>16</sub>	174.0	
6 5V 2800 J	28.00	27.90	B-3	J	4 <sup>1</sup> / <sub>16</sub>	1 <sup>1</sup> / <sub>16</sub>	2 <sup>1</sup> / <sub>16</sub>	3 <sup>1</sup> / <sub>16</sub>	1 <sup>1</sup> / <sub>16</sub>	169.0	7 5V 2800 J	C-3	J	4 <sup>1</sup> / <sub>16</sub>	1 <sup>1</sup> / <sub>16</sub>	4 <sup>1</sup> / <sub>16</sub>	4 <sup>1</sup> / <sub>16</sub>	1 <sup>1</sup> / <sub>16</sub>	169.0	
6 5V 3150 J	31.50	31.40	B-3	J	4 <sup>1</sup> / <sub>16</sub>	1 <sup>1</sup> / <sub>16</sub>	2 <sup>1</sup> / <sub>16</sub>	3 <sup>1</sup> / <sub>16</sub>	1 <sup>1</sup> / <sub>16</sub>	206.0	7 5V 3150 J	C-3	J	4 <sup>1</sup> / <sub>16</sub>	1 <sup>1</sup> / <sub>16</sub>	4 <sup>1</sup> / <sub>16</sub>	4 <sup>1</sup> / <sub>16</sub>	1 <sup>1</sup> / <sub>16</sub>	241.0	
6 5V 3750 J	37.50	37.40	B-3	J	4 <sup>1</sup> / <sub>16</sub>	1 <sup>1</sup> / <sub>16</sub>	2 <sup>1</sup> / <sub>16</sub>	3 <sup>1</sup> / <sub>16</sub>	1 <sup>1</sup> / <sub>16</sub>	241.0	7 5V 3750 M	C-3	M	5 <sup>1</sup> / <sub>16</sub>	1 <sup>1</sup> / <sub>16</sub>	6 <sup>1</sup> / <sub>16</sub>	2 <sup>1</sup> / <sub>16</sub>	1 <sup>1</sup> / <sub>16</sub>	300.0	
6 5V 5000 M	50.00	49.90	C-3	M	5 <sup>1</sup> / <sub>16</sub>	1 <sup>1</sup> / <sub>16</sub>	1 <sup>1</sup> / <sub>16</sub>	6 <sup>1</sup> / <sub>16</sub>	1 <sup>1</sup> / <sub>16</sub>	388.0	7 5V 5000 M	C-3	M	5 <sup>1</sup> / <sub>16</sub>	1 <sup>1</sup> / <sub>16</sub>	6 <sup>1</sup> / <sub>16</sub>	2 <sup>1</sup> / <sub>16</sub>	1 <sup>1</sup> / <sub>16</sub>	408.0	

NOTE: Dimensions in inches, weight in pounds. Weights do not include bushings. See page B-3 and B-4 for additional bushing dimensions.

\* E and M dimensions are nominal and will vary depending on shaft tolerances. Type E sheaves are drilled for reverse mounting only.



# 8V Hi-Cap Wedge Stock QD Sheaves



## QD Sheaves — 8V

4 Groove											5 Groove										
F = 4 1/8											F = 6										
Part Number	OD	PD 8V Belt	Type	Bush	Bush Max. Bore	E ☆	K	L Length Thru Bore	M ☆	Wt. Less Bush	Part Number	Type	Bush	Bush Max. Bore	E ☆	K	L Length Thru Bore	M ☆	Wt. Less Bush		
4 8V 1250 F	12.50	12.30	A-1	F	3 15/16	3/16	1 3/8	3 3/8	1 1/8	63.0	5 8V 1250 F	A-1	F	3 3/8	1 1/8	2 3/8	3 3/8	1 1/8	68.0		
4 8V 1320 F	13.20	13.00	A-2	F	3 15/16	3/16	1 3/8	3 3/8	1 1/8	66.0	5 8V 1320 F	A-2	F	3 3/8	1 1/8	2 3/8	3 3/8	1 1/8	75.0		
4 8V 1400 F	14.00	13.80	A-2	F	3 15/16	3/16	1 3/8	3 3/8	1 1/8	70.0	5 8V 1400 F	A-2	F	3 3/8	1 1/8	2 3/8	3 3/8	1 1/8	78.0		
4 8V 1500 F	15.00	14.80	A-2	F	3 15/16	3/16	1 3/8	3 3/8	1 1/8	74.0	5 8V 1500 F	A-2	F	3 3/8	1 1/8	2 3/8	3 3/8	1 1/8	94.0		
4 8V 1600 F	16.00	15.80	A-2	F	3 15/16	3/16	1 3/8	3 3/8	1 1/8	82.0	5 8V 1600 F	A-2	F	3 3/8	1 1/8	2 3/8	3 3/8	1 1/8	101.0		
4 8V 1700 F	17.00	16.80	A-3	F	3 15/16	3/16	1 3/8	3 3/8	1 1/8	94.0	5 8V 1700 J	A-3	J	4 1/2	1 1/8	2	4 1/2	1 1/8	111.0		
4 8V 1800 F	18.00	17.80	A-3	F	3 15/16	3/16	1 3/8	3 3/8	1 1/8	99.0	5 8V 1800 J	A-3	J	4 1/2	1 1/8	2	4 1/2	1 1/8	130.0		
4 8V 1900 F	19.00	18.80	A-3	F	3 15/16	3/16	1 3/8	3 3/8	1 1/8	105.0	5 8V 1900 J	A-3	J	4 1/2	1 1/8	2	4 1/2	1 1/8	135.0		
4 8V 2000 J	20.00	19.80	A-3	J	4 1/2	1/4	1 1/2	4 1/2	1/2	141.0	5 8V 2000 J	A-3	J	4 1/2	1 1/8	2	4 1/2	1 1/8	152.0		
4 8V 2120 J	21.20	21.00	A-3	J	4 1/2	1/4	1 1/2	4 1/2	1/2	150.0	5 8V 2120 J	A-3	J	4 1/2	1 1/8	2	4 1/2	1 1/8	153.0		
4 8V 2240 J	22.40	22.20	A-3	J	4 1/2	1/4	1 1/2	4 1/2	1/2	177.0	5 8V 2240 M	B-3	M	5 1/2	1/2	1 15/16	6 3/4	1 1/4	223.0		
4 8V 2480 M	24.80	24.60	C-3	M	5 1/2	3/8	1 3/4	6 3/4	1 1/4	223.0	5 8V 2480 M	B-3	M	5 1/2	1/2	1 15/16	6 3/4	1 1/4	234.0		
4 8V 3000 M	30.00	29.80	C-3	M	5 1/2	3/8	1 3/4	6 3/4	1 1/4	285.0	5 8V 3000 M	B-3	M	5 1/2	1/2	1 15/16	6 3/4	1 1/4	294.0		
4 8V 3550 M	35.50	35.30	C-3	M	5 1/2	3/8	1 3/4	6 3/4	1 1/4	305.0	5 8V 3550 M	B-3	M	5 1/2	1/2	1 15/16	6 3/4	1 1/4	325.0		
4 8V 4000 M	40.00	39.80	C-3	M	5 1/2	3/8	1 3/4	6 3/4	1 1/4	355.0	5 8V 4000 M	B-3	M	5 1/2	1/2	1 15/16	6 3/4	1 1/4	430.0		
4 8V 4450 M	44.50	44.30	C-3	M	5 1/2	3/8	1 3/4	6 3/4	1 1/4	369.0	5 8V 4450 N	C-3	N	6	1 3/8	1 5/8	8 1/2	1 3/8	485.0		
4 8V 5300 M	53.00	52.80	C-3	M	5 1/2	3/8	1 3/4	6 3/4	1 1/4	478.0	5 8V 5300 N	C-3	N	6	1 3/8	1 5/8	8 1/2	1 3/8	672.0		

NOTE: Dimensions in inches, weight in pounds. Weights do not include bushings. See page B-3 and B-4 for additional bushing dimensions.  
 ☆ E and M dimensions are nominal and will vary depending on shaft tolerances. Type E sheaves are drilled for reverse mounting only.

## QD Sheaves — 8V

6 Groove											8 Groove										
F = 7 1/8											F = 9 3/8										
Part Number	OD	PD 8V Belt	Type	Bush	Bush Max. Bore	E ☆	K	L Length Thru Bore	M ☆	Wt. Less Bush	Part Number	Type	Bush	Bush Max. Bore	E ☆	K	L Length Thru Bore	M ☆	Wt. Less Bush		
6 8V 1250 F	12.50	12.30	A-1	F	3 15/16	1 1/8	2 3/8	3 3/8	2 3/8	86.0	8 8V 1250 J	A-1	J	4 1/2	2 3/8	3 3/8	4 1/2	2 1/2	108.0		
6 8V 1320 F	13.20	13.00	A-1	F	3 15/16	1 1/8	2 3/8	3 3/8	2 3/8	94.0	8 8V 1320 J	A-1	J	4 1/2	2 3/8	3 3/8	4 1/2	2 1/2	118.0		
6 8V 1400 F	14.00	13.80	A-1	F	3 15/16	1 1/8	2 3/8	3 3/8	2 3/8	108.0	8 8V 1400 J	A-1	J	4 1/2	2 3/8	3 3/8	4 1/2	2 1/2	131.0		
6 8V 1500 J	15.00	14.80	A-1	J	4 1/2	1 3/8	2 3/8	4 1/2	1 1/4	138.0	8 8V 1500 J	A-1	J	4 1/2	2 3/8	3 3/8	4 1/2	2 1/2	151.0		
6 8V 1600 J	16.00	15.80	A-1	J	4 1/2	1 3/8	2 3/8	4 1/2	1 1/4	142.0	8 8V 1600 J	A-1	J	4 1/2	2 3/8	3 3/8	4 1/2	2 1/2	155.0		
6 8V 1700 J	17.00	16.80	A-2	J	4 1/2	1 3/8	2 3/8	4 1/2	1 1/4	144.0	8 8V 1700 M	A-2	M	5 1/2	2 1/2	3 15/16	6 3/4	1/8	188.0		
6 8V 1800 J	18.00	17.80	A-2	J	4 1/2	1 3/8	2 3/8	4 1/2	1 1/4	160.0	8 8V 1800 M	A-2	M	5 1/2	2 1/2	3 15/16	6 3/4	1/8	202.0		
6 8V 1900 J	19.00	18.80	A-2	J	4 1/2	1 3/8	2 3/8	4 1/2	1 1/4	172.0	8 8V 1900 M	A-2	M	5 1/2	2 1/2	3 15/16	6 3/4	1/8	221.0		
6 8V 2000 M	20.00	19.80	B-2	M	5 1/2	1 1/2	2 15/16	6 3/4	1 1/2	204.0	8 8V 2000 M	A-2	M	5 1/2	2 1/2	3 15/16	6 3/4	1/8	236.0		
6 8V 2120 M	21.20	21.00	B-2	M	5 1/2	1 1/2	2 15/16	6 3/4	1 1/2	226.0	8 8V 2120 M	A-2	M	5 1/2	2 1/2	3 15/16	6 3/4	1/8	267.0		
6 8V 2240 M	22.40	22.20	B-3	M	5 1/2	1 1/2	2 15/16	6 3/4	1 1/2	235.0	8 8V 2240 M	A-3	M	5 1/2	2 1/2	3 15/16	6 3/4	1/8	284.0		
6 8V 2480 M	24.80	24.60	B-3	M	5 1/2	1 1/2	1 15/16	6 3/4	1/2	246.0	8 8V 2480 N	A-2	N	6	1/2	2 1/4	8 1/2	3/4	418.0		
6 8V 3000 M	30.00	29.80	B-3	M	6	1/2	1 15/16	6 3/4	1/2	306.0	8 8V 3000 N	A-3	N	6	1/2	2 1/4	8 1/2	3/4	447.0		
6 8V 3550 N	35.50	35.30	C-3	N	6	3/8	1 1/2	8 1/2	3/4	466.0	8 8V 3550 N	A-3	N	6	1/2	2 1/4	8 1/2	3/4	553.0		
6 8V 4000 N	40.00	39.80	C-3	N	6	3/8	1 1/2	8 1/2	3/4	548.0	8 8V 4000 N	A-3	N	6	1/2	2 1/4	8 1/2	3/4	648.0		
6 8V 4450 N	44.50	44.30	C-3	N	6	3/8	1 1/2	8 1/2	3/4	590.0	8 8V 4450 P	B-3	P	6 3/4	3/4	2 3/8	9 1/2	3/8	679.0		
6 8V 5300 N	53.00	52.80	C-3	N	6	3/8	1 1/2	8 1/2	3/4	658.0	8 8V 5300 P	B-3	P	6 3/4	3/4	2 3/8	9 1/2	3/8	946.0		
6 8V 6300 P	63.00	62.80	C-3	P	6 3/4	0	2	9 1/2	1 1/2	860.0	8 8V 6300 P	B-3	P	6 3/4	3/4	2 3/8	9 1/2	1/4	1372.0		
6 8V 7100 P	71.00	70.80	B-3	P	6 3/4	0	2	9 1/2	1 1/2	1272.0	8 8V 7100 W	C-3	W	8 1/2	3/4	1 1/2	11 3/4	3/4	1680.0		

NOTE: Dimensions in inches, weight in pounds. Weights do not include bushings. See page B-3 and B-4 for additional bushing dimensions.  
 ☆ E and M dimensions are nominal and will vary depending on shaft tolerances. Type E sheaves are drilled for reverse mounting only.



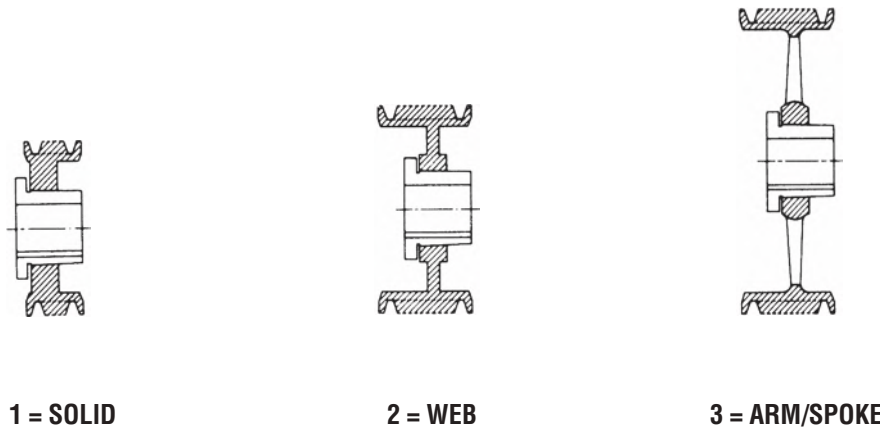
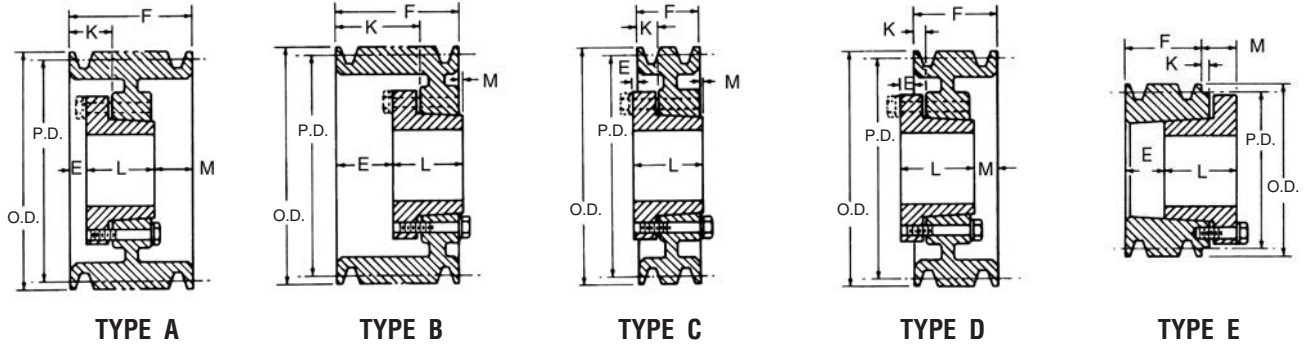

## QD Sheaves — 8V

10 Groove F = 11%											12 Groove F = 14								
Part Number	OD	PD 8V Belt	Type	Bush	Bush Max. Bore	E ☆	K	L Length Thru Bore	M ☆	Wt. Less Bush	Part Number	Type	Bush	Bush Max. Bore	E ☆	K	L Length Thru Bore	M ☆	Wt. Less Bush
10 8V 1320 J	13.20	13.00	A-1	J	4½	2%	3⅞	4½	4%	140.0	12 8V 1320 M	A-1	M	5½	2½	3⅞	6%	4%	185.0
10 8V 1400 J	14.00	13.80	A-1	J	4½	2%	3⅞	4½	4%	152.0	12 8V 1400 M	A-1	M	5½	2½	3⅞	6%	4%	211.0
10 8V 1500 M	15.00	14.80	A-1	M	5½	2½	3⅞	6%	2%	212.0	12 8V 1500 M	A-1	M	5½	2½	3⅞	6%	4%	234.0
10 8V 1600 M	16.00	15.80	A-1	M	5½	2½	3⅞	6%	2%	219.0	12 8V 1600 M	A-1	M	5½	2½	3⅞	6%	4%	285.0
10 8V 1700 M	17.00	16.80	A-2	M	5½	2½	3⅞	6%	2%	228.0	12 8V 1700 M	A-1	M	5½	2½	3⅞	6%	4%	324.0
10 8V 1800 M	18.00	17.80	A-2	M	5½	2½	3⅞	6%	2%	236.0	12 8V 1800 M	A-2	M	5½	2½	3⅞	6%	4%	330.0
10 8V 1900 M	19.00	18.80	A-2	M	5½	2½	3⅞	6%	2%	260.0	12 8V 1900 N	A-2	N	6	½	2¼	8%	5%	338.0
10 8V 2000 M	20.00	19.80	A-2	M	5½	2½	3⅞	6%	2%	280.0	12 8V 2000 N	A-2	N	6	½	2¼	8%	5%	365.0
10 8V 2120 M	21.20	21.00	A-2	M	5½	2½	3⅞	6%	2%	298.0	12 8V 2120 N	A-2	N	6	½	2¼	8%	5%	382.0
10 8V 2240 N	22.40	22.20	A-2	N	6	½	2¼	8%	3	366.0	12 8V 2240 N	A-2	N	6	½	2¼	8%	5%	399.0
10 8V 2480 N	24.80	24.60	A-2	N	6	½	2¼	8%	3	454.0	12 8V 2480 N	A-2	N	6	½	2¼	8%	5%	454.0
10 8V 3000 N	30.00	29.80	A-3	N	6	½	2¼	8%	3	468.0	12 8V 3000 P	A-3	P	6%	½	2%	9%	3%	605.0
10 8V 3550 P	35.50	35.30	A-3	P	6%	½	2%	9%	1%	784.0	12 8V 3550 P	A-3	P	6%	½	2%	9%	3%	706.0
10 8V 4000 P	40.00	39.80	A-3	P	6%	½	2%	9%	1%	826.0	12 8V 4000 P	A-3	P	6%	½	2%	9%	3%	766.0
10 8V 4450 P	44.50	44.30	A-3	P	6%	½	2%	9%	1%	996.0	12 8V 4450 P	A-3	P	6%	½	2%	9%	3%	910.0
10 8V 5300 W	53.00	52.80	A-3	P	6%	½	2%	9%	½	1010.0	12 8V 5300 W	A-3	W	8%	½	2%	11%	2%	1333.0
10 8V 6300 W	63.00	62.80	A-3	W	8%	½	2%	11%	0	1443.0	12 8V 6300 W	A-3	W	8%	½	2%	11%	2%	1777.0
10 8V 7100 W	71.00	70.80	A-3	W	8%	½	2%	11%	0	1842.0	12 8V 7100 W	A-3	W	8%	½	2%	11%	2%	2002.0

NOTE: Dimensions in inches, weight in pounds. Weights do not include bushings. See page B-3 and B-4 for additional bushing dimensions.  
 ☆ E and M dimensions are nominal and will vary depending on shaft tolerances. Type E sheaves are drilled for reverse mounting only.

# A-B Combination Groove Conventional Stock QD Sheaves

# Martin

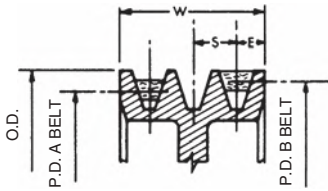

Combination Groove Dimensions

Belt Section	E	S	O.D.
"AB"	1/2	3/4	P.D. "B" + .35

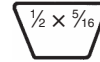

A

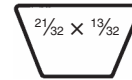

B

Drawing shows position of "A" and "B" belts in groove when used with QD sheaves.

## QD Sheaves — A-B

1 Groove											2 Groove									
F = 7/8 thru 1 B 64 SDS / F = 1 others											F = 1 3/4									
Part Number	PD		OD	Type	Bush	Bush Max. Bore	E ☆	K	L Length Thru Bore	M ☆	Wt. Less Bush	Part Number	Type	Bush	Bush Max. Bore	E ☆	K	L Length Thru Bore	M ☆	Wt. Less Bush
	A Belts	B Belts																		
1 B 34 SH	3.0	3.4	3.75	D-1	SH	1 1/16	3/16	0	1 1/16	1/8	1.4	2 B 34 SH	E-1	SH	1 1/16	1	0	1 1/16	3/16	2.8
1 B 36 SH	3.2	3.6	3.95	D-1	SH	1 1/16	3/16	0	1 1/16	1/8	1.6	2 B 36 SH	D-1	SH	1 1/16	3/8	3/16	1 1/16	13/16	2.8
1 B 38 SH	3.4	3.8	4.15	D-1	SH	1 1/16	3/16	0	1 1/16	1/8	1.2	2 B 38 SH	D-1	SH	1 1/16	3/8	3/16	1 1/16	13/16	3.3
1 B 40 SH	3.6	4.0	4.35	C-1	SH	1 1/16	1/4	3/16	1 1/16	3/16	2.2	2 B 40 SH	A-1	SH	1 1/16	1/2	1 1/16	1 1/16	5/8	3.4
1 B 42 SH	3.8	4.2	4.55	C-1	SH	1 1/16	1/4	3/16	1 1/16	3/16	6.9	2 B 42 SH	A-1	SH	1 1/16	1/2	1 1/16	1 1/16	5/8	3.8
1 B 44 SH	4.0	4.4	4.75	C-1	SH	1 1/16	1/4	3/16	1 1/16	3/16	2.9	2 B 44 SH	A-1	SH	1 1/16	1/2	1 1/16	1 1/16	5/8	4.6
1 B 46 SDS	4.2	4.6	4.95	C-1	SDS	2	3/16	3/16	1 1/16	3/16	2.6	2 B 46 SDS	A-2	SDS	2	1/2	1 1/16	1 1/16	5/8	4.3
1 B 48 SDS	4.4	4.8	5.15	C-1	SDS	2	3/16	3/16	1 1/16	3/16	3.1	2 B 48 SDS	A-2	SDS	2	1/2	1 1/16	1 1/16	5/8	4.8
1 B 50 SDS	4.6	5.0	5.35	C-1	SDS	2	3/16	3/16	1 1/16	3/16	3.5	2 B 50 SDS	A-2	SDS	2	1/2	1 1/16	1 1/16	5/8	5.5
1 B 52 SDS	4.8	5.2	5.55	C-1	SDS	2	3/16	3/16	1 1/16	3/16	3.7	2 B 52 SDS	A-2	SDS	2	1/2	1 1/16	1 1/16	5/8	5.8
1 B 54 SDS	5.0	5.4	5.75	C-1	SDS	2	3/16	3/16	1 1/16	3/16	4.0	2 B 54 SDS	A-2	SDS	2	1/2	1 1/16	1 1/16	5/8	6.1
1 B 56 SDS	5.2	5.6	5.95	C-1	SDS	2	3/16	3/16	1 1/16	3/16	4.2	2 B 56 SDS	A-2	SDS	2	1/2	1 1/16	1 1/16	5/8	6.6
1 B 58 SDS	5.4	5.8	6.15	C-1	SDS	2	3/16	3/16	1 1/16	3/16	4.5	2 B 58 SDS	A-1	SDS	2	1/2	1 1/16	1 1/16	5/8	7.2
1 B 60 SDS	5.6	6.0	6.35	C-1	SDS	2	3/16	3/16	1 1/16	3/16	4.9	2 B 60 SDS	A-2	SDS	2	1/2	1 1/16	1 1/16	5/8	7.6
1 B 62 SDS	5.8	6.2	6.55	C-2	SDS	2	3/16	3/16	1 1/16	3/16	5.5	2 B 62 SDS	A-2	SDS	2	1/2	1 1/16	1 1/16	5/8	7.0
1 B 64 SDS	6.0	6.4	6.75	C-2	SDS	2	3/16	3/16	1 1/16	3/16	5.7	2 B 64 SDS	A-2	SDS	2	1/2	1 1/16	1 1/16	5/8	7.0
1 B 66 SDS	6.2	6.6	6.95	C-2	SDS	2	3/16	3/16	1 1/16	3/16	5.9	2 B 66 SDS	A-2	SDS	2	1/2	1 1/16	1 1/16	5/8	9.0
1 B 68 SDS	6.4	6.8	7.15	C-2	SDS	2	3/16	3/16	1 1/16	3/16	4.8	2 B 68 SDS	A-2	SDS	2	1/2	1 1/16	1 1/16	5/8	9.2
1 B 70 SDS	6.6	7.0	7.35	C-2	SDS	2	1/2	1/2	1 1/16	1/2	5.8	2 B 70 SK	D-2	SK	2 3/8	1/4	7/16	1 15/16	1/8	8.8
1 B 74 SDS	7.0	7.4	7.75	C-2	SDS	2	1/2	1/2	1 1/16	1/2	6.4	2 B 74 SK	D-2	SK	2 3/8	1/4	7/16	1 15/16	1/8	11.0
1 B 80 SDS	7.6	8.0	8.35	C-3	SDS	2	1/2	1/2	1 1/16	1/2	6.8	2 B 80 SK	D-2	SK	2 3/8	1/4	7/16	1 15/16	1/8	12.6
1 B 86 SDS	8.2	8.6	8.95	C-3	SDS	2	1/2	1/2	1 1/16	1/2	7.2	2 B 86 SK	D-3	SK	2 3/8	1/4	7/16	1 15/16	1/8	12.0
1 B 94 SDS	9.0	9.4	9.75	C-3	SDS	2	1/2	1/2	1 1/16	1/2	8.0	2 B 94 SK	D-3	SK	2 3/8	1/4	7/16	1 15/16	1/8	13.4
1 B 110 SDS	10.6	11.0	11.35	C-3	SDS	2	1/2	1/2	1 1/16	1/2	9.0	2 B 110 SK	D-3	SK	2 3/8	1/4	7/16	1 15/16	1/8	16.4
1 B 124 SDS	12.0	12.4	12.75	C-3	SDS	2	1/2	1/2	1 1/16	1/2	11.0	2 B 124 SK	D-3	SK	2 3/8	1/4	7/16	1 15/16	1/8	19.2
1 B 136 SDS	13.2	13.6	13.95	C-3	SDS	2	1/2	1/2	1 1/16	1/2	12.0	2 B 136 SK	D-3	SK	2 3/8	1/4	7/16	1 15/16	1/8	19.0
1 B 154 SK	15.0	15.4	15.75	C-3	SK	2 3/8	3/8	1/2	1 15/16	3/8	13.0	2 B 154 SK	D-3	SK	2 3/8	1/4	7/16	1 15/16	1/8	22.0
1 B 160 SK	15.6	16.0	16.35	C-3	SK	2 3/8	3/8	1/2	1 15/16	3/8	15.0	2 B 160 SK	D-3	SK	2 3/8	1/4	7/16	1 15/16	1/8	26.0
1 B 184 SK	18.0	18.4	18.75	C-3	SK	2 3/8	3/8	1/2	1 15/16	3/8	19.0	2 B 184 SK	D-3	SK	2 3/8	1/4	7/16	1 15/16	1/8	30.0
1 B 200 SK	19.6	20.0	20.35	C-3	SK	2 3/8	3/8	1/2	1 15/16	3/8	25.0	2 B 200 SF	D-3	SF	2 3/8	3/8	3/8	2 1/2	0	35.0
	24.6	25.0	25.35									2 B 250 SF	D-3	SF	2 3/8	3/8	3/8	2 1/2	0	57.0
	29.6	30.0	30.35									2 B 300 SF	D-3	SF	2 3/8	3/8	3/8	2 1/2	0	80.0
	37.6	38.0	38.35									2 B 380 SF	D-3	SF	2 3/8	3/8	3/8	2 1/2	0	99.0

NOTE: Dimensions in inches, weight in pounds. Weights do not include bushings. See page B-3 and B-4 for additional bushing dimensions.  
 ☆ E and M dimensions are nominal and will vary depending on shaft tolerances. Type E sheaves are drilled for reverse mounting only.

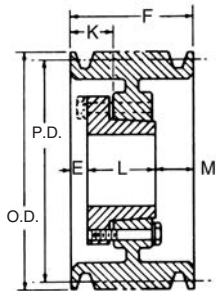

**TYPE A**

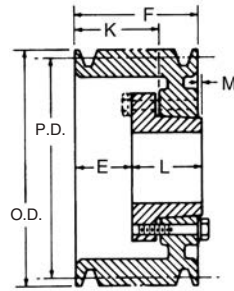

**TYPE B**

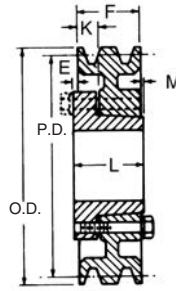

**TYPE C**

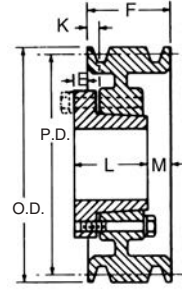

**TYPE D**

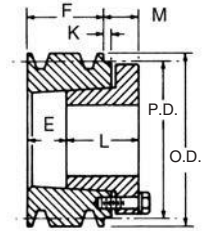

**TYPE E**

## QD Sheaves — A-B

3 Groove F = 2½												4 Groove F = ¾									
Part Number	PD		OD	Type	Bush	Bush Max. Bore	E ☆	K	L Length Thru Bore	M ☆	Wt. Less Bush	Part Number	Type	Bush	Bush Max. Bore	E ☆	K	L Length Thru Bore	M ☆	Wt. Less Bush	
	A Belts	B Belts																			
3 B 34 SH	3.0	3.4	3.75	E-1	SH	1 1/16	1 3/4	0	1 5/16	9/16	3.4	4 B 34 SD	E-1	SD	2	2 3/8	5/16	1 1/16	1 5/16	4.0	
3 B 36 SH	3.2	3.6	3.95	E-1	SH	1 1/16	3/4	0	1 5/16	1 1/8	3.8	4 B 36 SD	E-1	SD	2	2 3/8	5/16	1 1/16	1 5/16	5.0	
3 B 38 SH	3.4	3.8	4.15	E-1	SH	1 1/16	3/4	0	1 5/16	1 1/8	4.0	4 B 38 SD	E-1	SD	2	2 3/8	5/16	1 1/16	1 5/16	5.5	
3 B 40 SH	3.6	4.0	4.35	A-1	SH	1 1/16	1/2	1 1/8	1 5/16	1 1/8	4.5	4 B 40 SD	E-1	SD	2	2 3/8	0	1 1/16	5/8	6.0	
3 B 42 SH	3.8	4.2	4.55	A-1	SH	1 1/16	1/2	1 1/8	1 5/16	1 1/8	5.0	4 B 42 SD	E-1	SD	2	2 3/8	0	1 1/16	5/8	7.0	
3 B 44 SH	4.0	4.4	4.75	A-1	SH	1 1/16	1/2	1 1/8	1 5/16	1 1/8	5.5	4 B 44 SD	E-1	SD	2	2 3/8	0	1 1/16	5/8	7.3	
3 B 46 SD	4.2	4.6	4.95	A-1	SD	2	7/16	1 1/8	1 5/16	1/4	6.0	4 B 46 SD	A-1	SD	2	1 1/8	1 1/8	1 1/8	3/4	7.6	
3 B 48 SD	4.4	4.8	5.15	A-1	SD	2	7/16	1 1/8	1 5/16	1/4	6.5	4 B 48 SD	A-1	SD	2	1 1/8	1 1/8	1 1/8	3/4	8.0	
3 B 50 SD	4.6	5.0	5.35	A-1	SD	2	7/16	1 1/8	1 5/16	1/4	7.0	4 B 50 SD	A-1	SD	2	1 1/8	1 1/8	1 1/8	3/4	9.0	
3 B 52 SD	4.8	5.2	5.55	A-1	SD	2	7/16	1 1/8	1 5/16	1/4	8.0	4 B 52 SD	A-1	SD	2	1 1/8	1 1/8	1 1/8	3/4	10.0	
3 B 54 SD	5.0	5.4	5.75	A-1	SD	2	7/16	1 1/8	1 5/16	1/4	8.5	4 B 54 SD	A-1	SD	2	1 1/8	1 1/8	1 1/8	3/4	10.5	
3 B 56 SD	5.2	5.6	5.95	A-1	SD	2	7/16	1 1/8	1 5/16	1/4	9.0	4 B 56 SD	A-1	SD	2	1 1/8	1 1/8	1 1/8	3/4	11.0	
3 B 58 SD	5.4	5.8	6.15	A-1	SD	2	7/16	1 1/8	1 5/16	1/4	10.0	4 B 58 SD	A-1	SD	2	1 1/8	1 1/8	1 1/8	3/4	12.0	
3 B 60 SD	5.6	6.0	6.35	A-1	SD	2	7/16	1 1/8	1 5/16	1/4	11.0	4 B 60 SD	A-1	SD	2	1 1/8	1 1/8	1 1/8	3/4	12.5	
3 B 62 SD	5.8	6.2	6.55	A-1	SD	2	7/16	1 1/8	1 5/16	1/4	12.0	4 B 62 SD	A-1	SD	2	1 1/8	1 1/8	1 1/8	3/4	13.0	
3 B 64 SD	6.0	6.4	6.75	A-1	SD	2	7/16	1 1/8	1 5/16	1/4	12.3	4 B 64 SD	A-1	SD	2	1 1/8	1 1/8	1 1/8	3/4	14.0	
3 B 66 SD	6.2	6.6	6.95	A-1	SD	2	7/16	1 1/8	1 5/16	1/4	12.6	4 B 66 SD	A-1	SD	2	1 1/8	1 1/8	1 1/8	3/4	14.5	
3 B 68 SD	6.4	6.8	7.15	A-1	SD	2	7/16	1 1/8	1 5/16	1/4	13.0	4 B 68 SD	A-1	SD	2	1 1/8	1 1/8	1 1/8	3/4	15.0	
3 B 70 SK	6.6	7.0	7.35	A-1	SK	2 3/8	0	1 1/8	1 5/16	9/16	14.0	4 B 70 SK	A-1	SK	2 3/8	5/16	1	1 1/16	1	15.5	
3 B 74 SK	7.0	7.4	7.75	A-1	SK	2 3/8	0	1 1/8	1 5/16	9/16	15.0	4 B 74 SK	A-1	SK	2 3/8	5/16	1	1 1/16	1	16.0	
3 B 80 SK	7.6	8.0	8.35	A-1	SK	2 3/8	0	1 1/8	1 5/16	9/16	16.0	4 B 80 SK	A-1	SK	2 3/8	5/16	1	1 1/16	1	17.0	
3 B 86 SK	8.2	8.6	8.95	A-3	SK	2 3/8	0	1 1/8	1 5/16	9/16	17.0	4 B 86 SK	A-3	SK	2 3/8	5/16	1	1 1/16	1	18.0	
3 B 94 SK	9.0	9.4	9.75	A-3	SK	2 3/8	0	1 1/8	1 5/16	9/16	18.0	4 B 94 SK	A-3	SK	2 3/8	5/16	1	1 1/16	1	19.0	
3 B 110 SK	10.6	11.0	11.35	A-3	SK	2 3/8	0	1 1/8	1 5/16	9/16	19.0	4 B 110 SK	A-3	SK	2 3/8	5/16	1	1 1/16	1	24.0	
3 B 124 SK	12.0	12.4	12.75	A-3	SK	2 3/8	0	1 1/8	1 5/16	9/16	23.0	4 B 124 SK	A-3	SK	2 3/8	5/16	1	1 1/16	1	26.0	
3 B 136 SK	13.2	13.6	13.95	A-3	SK	2 3/8	0	1 1/8	1 5/16	9/16	24.1	4 B 136 SK	A-3	SK	2 3/8	5/16	1	1 1/16	1	28.0	
3 B 154 SK	15.0	15.4	15.75	A-3	SK	2 3/8	0	1 1/8	1 5/16	9/16	28.0	4 B 154 SF	A-3	SF	2 15/16	5/16	1	2 1/16	7/8	41.0	
3 B 160 SK	15.6	16.0	16.35	A-3	SK	2 3/8	0	1 1/8	1 5/16	9/16	29.0	4 B 160 SF	A-3	SF	2 15/16	5/16	1	2 1/16	7/8	42.0	
3 B 184 SK	18.0	18.4	18.75	A-3	SK	2 3/8	0	1 1/8	1 5/16	9/16	37.0	4 B 184 SF	A-3	SF	2 15/16	5/16	1	2 1/16	7/8	48.0	
3 B 200 SF	19.6	20.0	20.35	D-3	SF	2 3/8	1/16	3/8	2 1/16	1/2	39.0	4 B 200 SF	A-3	SF	2 15/16	5/16	1	2 1/16	7/8	58.0	
3 B 250 SF	24.6	25.0	25.35	D-3	SF	2 15/16	1/16	3/8	2 1/16	1/2	67.0	4 B 250 E	A-3	E	3 1/2	1/8	1	2 3/8	1 1/2	78.0	
3 B 300 SF	29.6	30.0	30.35	D-3	SF	2 3/8	1/16	3/8	2 1/16	1/2	74.0	4 B 300 E	A-3	E	3 1/2	1/8	1	2 3/8	1 1/2	93.0	
3 B 380 E	37.6	38.0	38.35	D-3	E	3 1/2	1/4	3/8	2 3/8	1/2	122.0	4 B 380 E	A-3	E	3 1/2	1/8	1	2 3/8	1 1/2	138.0	

NOTE: Dimensions in inches, weight in pounds. Weights do not include bushings. See page B-3 and B-4 for additional bushing dimensions.  
 ☆ E and M dimensions are nominal and will vary depending on shaft tolerances. Type E sheaves are drilled for reverse mounting only.

# A-B Combination Groove Conventional Stock QD Sheaves

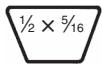

A

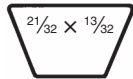

B

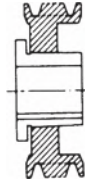

1 = SOLID

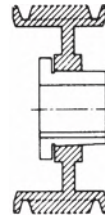

2 = WEB

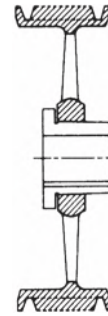

3 = ARM/SPOKE

## QD Sheaves — A-B

5 Groove F = 4												6 Groove F = 4 3/4								
Part Number	PD		OD	Type	Bush	Bush Max. Bore	E ☆	K	L Length Thru Bore	M ☆	Wt. Less Bush	Part Number	Type	Bush	Bush Max. Bore	E ☆	K	L Length Thru Bore	M ☆	Wt. Less Bush
	A Belts	B Belts																		
5 B 34 SD	3.0	3.4	3.75	E-1	SD	2	3/4	7/16	1 1/16	1 1/16	5.0	6 B 34 SD	E-1	SD	2	3/8	5/16	1 1/16	1 5/16	6.0
5 B 36 SD	3.2	3.6	3.95	E-1	SD	2	3/4	7/16	1 1/16	1 1/16	6.0	6 B 36 SD	E-1	SD	2	3/8	5/16	1 1/16	1 5/16	7.0
5 B 38 SD	3.4	3.8	4.15	E-1	SD	2	3/4	7/16	1 1/16	1 1/16	6.5	6 B 38 SD	E-1	SD	2	3/8	5/16	1 1/16	1 5/16	7.5
5 B 40 SD	3.6	4.0	4.35	E-1	SD	2	2 3/16	0	1 1/16	5/8	7.0	6 B 40 SD	E-1	SD	2	3/8	0	1 1/16	5/8	8.0
5 B 42 SD	3.8	4.2	4.55	E-1	SD	2	2 3/16	0	1 1/16	5/8	7.5	6 B 42 SD	E-1	SD	2	3/8	0	1 1/16	5/8	9.0
5 B 44 SD	4.0	4.4	4.75	E-1	SD	2	2 3/16	0	1 1/16	5/8	8.0	6 B 44 SD	E-1	SD	2	3/8	0	1 1/16	5/8	9.5
5 B 46 SD	4.2	4.6	4.95	A-1	SD	2	1 1/16	1 1/16	1 1/16	1 1/2	9.0	6 B 46 SD	A-1	SD	2	2 1/4	1 1/16	1 1/16	2 3/8	10.0
5 B 48 SD	4.4	4.8	5.15	A-1	SD	2	1 1/16	1 1/16	1 1/16	1 1/2	9.5	6 B 48 SD	A-1	SD	2	2 1/4	1 1/16	1 1/16	2 3/8	10.5
5 B 50 SD	4.6	5.0	5.35	A-1	SD	2	1 1/16	1 1/16	1 1/16	1 1/2	10.0	6 B 50 SD	A-1	SD	2	2 1/4	1 1/16	1 1/16	2 3/8	11.0
5 B 52 SD	4.8	5.2	5.55	A-1	SD	2	1 1/16	1 1/16	1 1/16	1 1/2	10.5	6 B 52 SD	A-1	SD	2	2 1/4	1 1/16	1 1/16	2 3/8	11.5
5 B 54 SK	5.0	5.4	5.75	A-1	SK	2 5/16	5/8	1 1/16	1 1/16	1 7/16	11.0	6 B 54 SK	A-1	SK	2 5/16	5/8	1 1/16	1 1/16	2 3/8	12.0
5 B 56 SK	5.2	5.6	5.95	A-1	SK	2 5/16	5/8	1 1/16	1 1/16	1 7/16	11.5	6 B 56 SK	A-1	SK	2 5/16	5/8	1 1/16	1 1/16	2 3/8	13.0
5 B 58 SK	5.4	5.8	6.15	A-1	SK	2 5/16	5/8	1 1/16	1 1/16	1 7/16	12.0	6 B 58 SK	A-1	SK	2 5/16	5/8	1 1/16	1 1/16	2 3/8	14.0
5 B 60 SK	5.6	6.0	6.35	A-1	SK	2 5/16	5/8	1 1/16	1 1/16	1 7/16	13.0	6 B 60 SK	A-1	SK	2 5/16	5/8	1 1/16	1 1/16	2 3/8	15.0
5 B 62 SK	5.8	6.2	6.55	A-1	SK	2 5/16	5/8	1 1/16	1 1/16	1 7/16	14.0	6 B 62 SK	A-1	SK	2 5/16	5/8	1 1/16	1 1/16	2 3/8	16.0
5 B 64 SK	6.0	6.4	6.75	A-1	SK	2 5/16	5/8	1 1/16	1 1/16	1 7/16	15.0	6 B 64 SK	A-1	SK	2 5/16	5/8	1 1/16	1 1/16	2 3/8	17.0
5 B 66 SK	6.2	6.6	6.95	A-1	SK	2 5/16	5/8	1 1/16	1 1/16	1 7/16	16.0	6 B 66 SK	A-1	SK	2 5/16	5/8	1 1/16	1 1/16	2 3/8	18.0
5 B 68 SK	6.4	6.8	7.15	A-1	SK	2 5/16	5/8	1 1/16	1 1/16	1 7/16	17.0	6 B 68 SK	A-1	SK	2 5/16	5/8	1 1/16	1 1/16	2 3/8	19.0
5 B 70 SF	6.6	7.0	7.35	A-1	SF	2 5/16	5/8	1 1/16	2 1/16	1 7/16	18.0	6 B 70 SF	A-1	SF	2 5/16	1	1 1/16	2 1/16	1 1/16	19.5
5 B 74 SF	7.0	7.4	7.75	A-1	SF	2 5/16	5/8	1 1/16	2 1/16	1 7/16	20.0	6 B 74 SF	A-1	SF	2 5/16	1	1 1/16	2 1/16	1 1/16	22.0
5 B 80 SF	7.6	8.0	8.35	A-1	SF	2 5/16	5/8	1 1/16	2 1/16	1 7/16	23.0	6 B 80 SF	A-1	SF	2 5/16	1	1 1/16	2 1/16	1 1/16	25.0
5 B 86 SF	8.2	8.6	8.95	A-2	SF	2 5/16	5/8	1 1/16	2 1/16	1 7/16	24.0	6 B 86 SF	A-2	SF	2 5/16	1	1 1/16	2 1/16	1 1/16	28.0
5 B 94 SF	9.0	9.4	9.75	A-2	SF	2 5/16	5/8	1 1/16	2 1/16	1 7/16	26.0	6 B 94 SF	A-2	SF	2 5/16	1	1 1/16	2 1/16	1 1/16	29.0
5 B 110 SF	10.6	11.0	11.35	A-2	SF	2 5/16	5/8	1 1/16	2 1/16	1 7/16	32.0	6 B 110 SF	A-2	SF	2 5/16	1	1 1/16	2 1/16	1 1/16	30.0
5 B 124 SF	12.0	12.4	12.75	A-3	SF	2 5/16	5/8	1 1/16	2 1/16	1 7/16	35.0	6 B 124 SF	A-3	SF	2 5/16	1	1 1/16	2 1/16	1 1/16	40.0
5 B 136 SF	13.2	13.6	13.95	A-3	SF	2 5/16	5/8	1 1/16	2 1/16	1 7/16	36.0	6 B 136 SF	A-3	SF	2 5/16	1	1 1/16	2 1/16	1 1/16	45.0
5 B 154 SF	15.0	15.4	15.75	A-3	SF	2 5/16	5/8	1 1/16	2 1/16	1 7/16	46.0	6 B 154 SF	A-3	SF	2 5/16	1	1 1/16	2 1/16	1 1/16	46.0
5 B 160 SF	15.6	16.0	16.35	A-3	SF	2 5/16	5/8	1 1/16	2 1/16	1 7/16	48.0	6 B 160 SF	A-3	SF	2 5/16	1	1 1/16	2 1/16	1 1/16	50.0
5 B 184 SF	18.0	18.4	18.75	A-3	SF	2 5/16	5/8	1 1/16	2 1/16	1 7/16	50.0	6 B 184 SF	A-3	SF	2 5/16	1	1 1/16	2 1/16	1 1/16	60.0
5 B 200 E	19.6	20.0	20.35	A-3	E	3 1/2	5/8	1 1/4	2 5/8	1	72.0	6 B 200 E	A-3	E	3 1/2	1/2	1 3/8	2 5/8	1 1/8	78.0
5 B 250 E	24.6	25.0	25.35	A-3	E	3 1/2	5/8	1 1/4	2 5/8	1	90.0	6 B 250 E	A-3	E	3 1/2	1/2	1 3/8	2 5/8	1 1/8	98.0
5 B 300 E	29.6	30.0	30.35	A-3	E	3 1/2	5/8	1 1/4	2 5/8	1	108.0	6 B 300 E	A-3	E	3 1/2	1/2	1 3/8	2 5/8	1 1/8	109.0
5 B 380 E	37.6	38.0	38.35	A-3	E	3 1/2	5/8	1 1/4	2 5/8	1	145.0	6 B 380 E	A-3	E	3 1/2	1/2	1 3/8	2 5/8	1 1/8	173.0

NOTE: Dimensions in inches, weight in pounds. Weights do not include bushings. See page B-3 and B-4 for additional bushing dimensions.

☆ E and M dimensions are nominal and will vary depending on shaft tolerances. Type E sheaves are drilled for reverse mounting only.

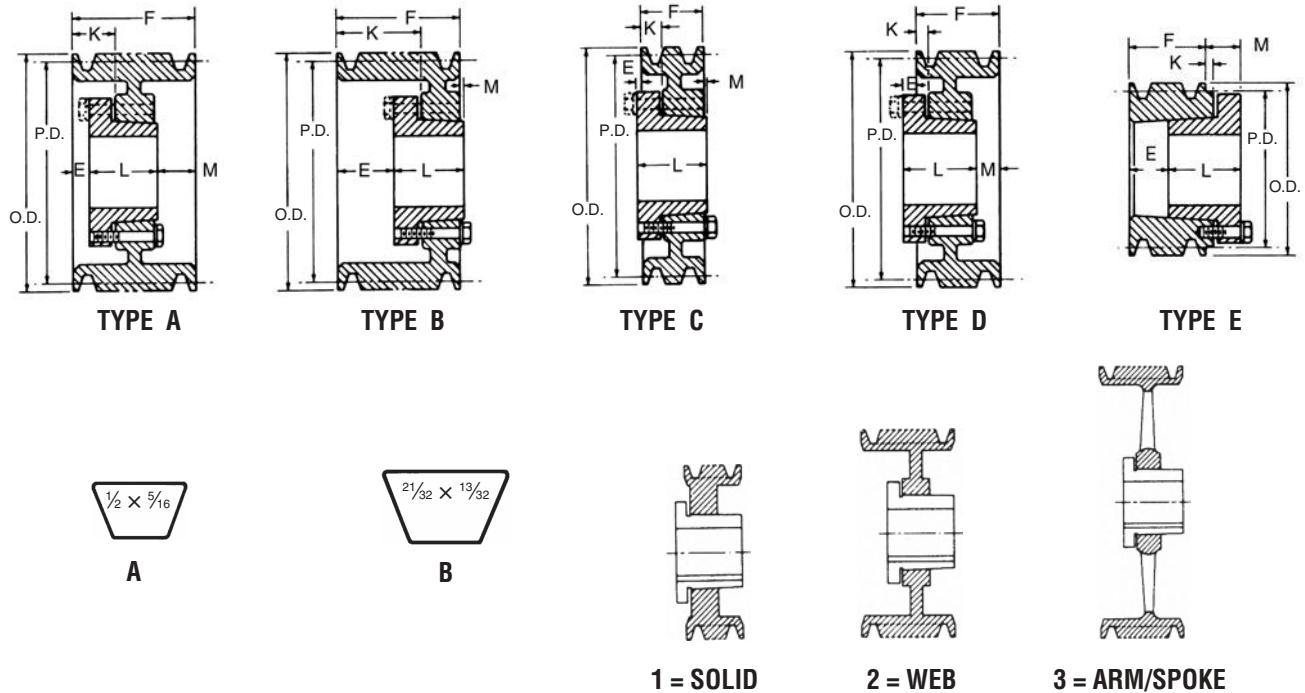

## QD Sheaves — A-B

8 Groove F = 6 1/4											10 Groove F = 7 1/4									
Part Number	PD		OD	Type	Bush	Bush Max. Bore	E ☆	K	L Length Thru Bore	M ☆	Wt. Less Bush	Part Number	Type	Bush	Bush Max. Bore	E ☆	K	L Length Thru Bore	M ☆	Wt. Less Bush
	A Belts	B Belts																		
8 B 54 SK	5.0	5.4	5.75	A-1	SK	2 1/2	1 1/2	1 1/2	1 1/2	3 1/2	14.0	10 B 54 SK	A-1	SK	2 1/2	1 1/2	2 1/2	1 1/2	3 1/2	15.0
8 B 56 SK	5.2	5.6	5.95	A-1	SK	2 1/2	1 1/2	1 1/2	1 1/2	3 1/2	16.0	10 B 56 SK	A-1	SK	2 1/2	1 1/2	2 1/2	1 1/2	3 1/2	18.0
8 B 58 SK	5.4	5.8	6.15	A-1	SK	2 1/2	1 1/2	1 1/2	1 1/2	3 1/2	16.5	10 B 58 SK	A-1	SK	2 1/2	1 1/2	2 1/2	1 1/2	3 1/2	20.0
8 B 60 SF	5.6	6.0	6.35	A-1	SF	2 1/2	1 1/2	1 1/2	2 1/2	3 1/2	17.0	10 B 60 SF	A-1	SF	2 1/2	1 1/2	2 1/2	2 1/2	3 1/2	22.0
8 B 62 SF	5.8	6.2	6.55	A-1	SF	2 1/2	1 1/2	1 1/2	2 1/2	3 1/2	18.0	10 B 62 SF	A-1	SF	2 1/2	1 1/2	2 1/2	2 1/2	3 1/2	24.0
8 B 64 SF	6.0	6.4	6.75	A-1	SF	2 1/2	1 1/2	1 1/2	2 1/2	3 1/2	18.5	10 B 64 SF	A-1	SF	2 1/2	1 1/2	2 1/2	2 1/2	3 1/2	25.0
8 B 66 SF	6.2	6.6	6.95	A-1	SF	2 1/2	1 1/2	1 1/2	2 1/2	3 1/2	21.0	10 B 66 SF	A-1	SF	2 1/2	1 1/2	2 1/2	2 1/2	3 1/2	26.0
8 B 68 SF	6.4	6.8	7.15	A-1	SF	2 1/2	1 1/2	1 1/2	2 1/2	3 1/2	22.0	10 B 68 SF	A-1	SF	2 1/2	1 1/2	2 1/2	2 1/2	3 1/2	27.0
8 B 70 SF	6.6	7.0	7.35	A-1	SF	2 1/2	1 1/2	1 1/2	2 1/2	3 1/2	22.5	10 B 70 SF	A-1	SF	2 1/2	1 1/2	2 1/2	2 1/2	3 1/2	28.0
8 B 74 SF	7.0	7.4	7.75	A-1	SF	2 1/2	1 1/2	1 1/2	2 1/2	3 1/2	25.0	10 B 74 SF	A-1	SF	2 1/2	1 1/2	2 1/2	2 1/2	3 1/2	31.0
8 B 80 SF	7.6	8.0	8.35	A-1	SF	2 1/2	1 1/2	1 1/2	2 1/2	3 1/2	29.0	10 B 80 SF	A-1	SF	2 1/2	1 1/2	2 1/2	2 1/2	3 1/2	35.0
8 B 86 E	8.2	8.6	8.95	A-1	E	3 1/2	1 1/2	2 1/2	2 1/2	2 1/2	34.0	10 B 86 E	A-1	E	3 1/2	2 1/2	3 1/2	2 1/2	2 1/2	38.0
8 B 94 E	9.0	9.4	9.75	A-1	E	3 1/2	1 1/2	2 1/2	2 1/2	2 1/2	40.0	10 B 94 E	A-1	E	3 1/2	2 1/2	3 1/2	2 1/2	2 1/2	45.0
8 B 110 E	10.6	11.0	11.35	A-2	E	3 1/2	1 1/2	2 1/2	2 1/2	2 1/2	47.0	10 B 110 E	A-2	E	3 1/2	2 1/2	3 1/2	2 1/2	2 1/2	53.0
8 B 124 E	12.0	12.4	12.75	A-3	E	3 1/2	1 1/2	2 1/2	2 1/2	2 1/2	52.0	10 B 124 E	A-3	E	3 1/2	2 1/2	3 1/2	2 1/2	2 1/2	63.0
8 B 136 E	13.2	13.6	13.95	A-3	E	3 1/2	1 1/2	2 1/2	2 1/2	2 1/2	60.0	10 B 136 F	A-3	F	3 1/2	1 1/2	2 1/2	3 1/2	3 1/2	78.0
8 B 154 E	15.0	15.4	15.75	A-3	E	3 1/2	1 1/2	2 1/2	2 1/2	2 1/2	82.0	10 B 154 F	A-3	F	3 1/2	1 1/2	2 1/2	3 1/2	3 1/2	90.0
8 B 160 E	15.6	16.0	16.35	A-3	E	3 1/2	1 1/2	2 1/2	2 1/2	2 1/2	90.0	10 B 160 F	A-3	F	3 1/2	1 1/2	2 1/2	3 1/2	3 1/2	96.0
8 B 184 F	18.0	18.4	18.75	A-3	F	3 1/2	1 1/2	3 1/2	3 1/2	2 1/2	110.0	10 B 184 F	A-3	F	3 1/2	1 1/2	2 1/2	3 1/2	3 1/2	113.0
8 B 200 F	19.6	20.0	20.35	A-3	F	3 1/2	1 1/2	3 1/2	3 1/2	2 1/2	122.0	10 B 200 F	A-3	F	3 1/2	1 1/2	2 1/2	3 1/2	3 1/2	114.0
8 B 250 F	24.6	25.0	25.35	A-3	F	3 1/2	1 1/2	3 1/2	3 1/2	2 1/2	138.0	10 B 250 F	A-3	F	3 1/2	1 1/2	2 1/2	3 1/2	3 1/2	138.0
8 B 300 F	29.6	30.0	30.35	A-3	F	3 1/2	1 1/2	3 1/2	3 1/2	2 1/2	168.0	10 B 300 F	A-3	F	3 1/2	1 1/2	2 1/2	3 1/2	3 1/2	200.0
8 B 380 F	37.6	38.0	38.35	A-3	F	3 1/2	1 1/2	3 1/2	3 1/2	2 1/2	222.0	10 B 380 J	A-3	J	4 1/2	3 1/2	4 1/2	2 1/2	2 1/2	279.0

NOTE: Dimensions in inches, weight in pounds. Weights do not include bushings. See page B-3 and B-4 for additional bushing dimensions.  
 ☆ E and M dimensions are nominal and will vary depending on shaft tolerances. Type E sheaves are drilled for reverse mounting only.

# C Conventional Stock QD Sheaves

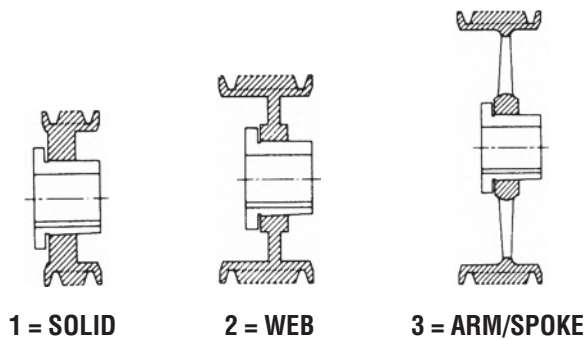
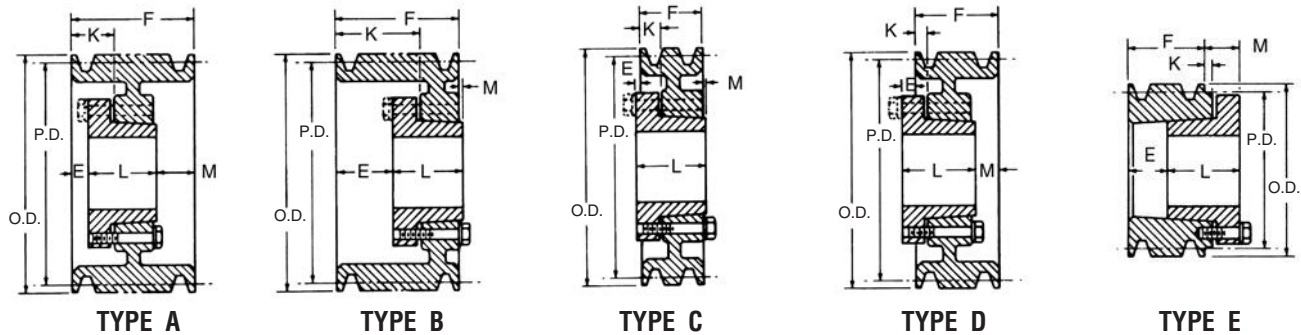

## QD Sheaves — C

1 Groove F = 1 3/8										2 Groove F = 2 3/8									
Part Number	PD	OD	Type	Bush	Bush Max. Bore	E ☆	K	L Length Thru Bore	M ☆	Wt. Less Bush	Part Number	Type	Bush	Bush Max. Bore	E ☆	K	L Length Thru Bore	M ☆	Wt. Less Bush
	C Belt																		
1 C 60 SK	6.00	6.40	C-1	SK	2 5/16	5/16	5/8	1 1/16	0	9.4	2 C 60 SF	A-1	SF	2 5/16	5/16	7/8	2 1/16	1/8	8.0
1 C 70 SF	7.00	7.40	C-1	SF	2 5/16	5/16	5/8	2 1/16	5/8	9.8	2 C 70 SF	A-1	SF	2 5/16	5/16	1 1/16	2 1/16	3/16	12.0
1 C 75 SF	7.50	7.90	C-1	SF	2 5/16	5/16	5/8	2 1/16	5/8	11.0	2 C 75 SF	A-1	SF	2 5/16	5/16	1 1/16	2 1/16	3/16	15.0
1 C 80 SF	8.00	8.40	C-1	SF	2 5/16	5/16	5/8	2 1/16	5/8	13.0	2 C 80 SF	A-1	SF	2 5/16	5/16	1 1/16	2 1/16	3/16	16.0
1 C 85 SF	8.50	8.90	C-1	SF	2 5/16	5/16	5/8	2 1/16	5/8	13.3	2 C 85 SF	A-1	SF	2 5/16	5/16	1 1/16	2 1/16	3/16	19.0
1 C 90 SF	9.00	9.40	C-3	SF	2 5/16	5/16	5/8	2 1/16	5/8	13.5	2 C 90 SF	A-2	SF	2 5/16	5/16	1 1/16	2 1/16	3/16	19.5
1 C 95 SF	9.50	9.90	C-3	SF	2 5/16	5/16	5/8	2 1/16	5/8	13.8	2 C 95 SF	A-2	SF	2 5/16	5/16	1 1/16	2 1/16	3/16	21.0
1 C 100 SF	10.00	10.40	C-3	SF	2 5/16	5/16	5/8	2 1/16	5/8	14.0	2 C 100 SF	A-2	SF	2 5/16	5/16	1 1/16	2 1/16	3/16	22.0
1 C 105 SF	10.50	10.90	C-3	SF	2 5/16	5/16	5/8	2 1/16	5/8	15.0	2 C 105 SF	A-2	SF	2 5/16	5/16	1 1/16	2 1/16	3/16	25.0
1 C 110 SF	11.00	11.40	C-3	SF	2 5/16	5/16	5/8	2 1/16	5/8	15.8	2 C 110 SF	A-3	SF	2 5/16	5/16	1 1/16	2 1/16	3/16	26.0
1 C 120 SF	12.00	12.40	C-3	SF	2 5/16	5/16	5/8	2 1/16	5/8	17.0	2 C 120 SF	D-3	SF	2 5/16	5/16	5/16	2 1/16	7/16	29.0
1 C 130 SF	13.00	13.40	C-3	SF	2 5/16	5/16	5/8	2 1/16	5/8	18.0	2 C 130 SF	D-3	SF	2 5/16	5/16	5/16	2 1/16	7/16	31.0
1 C 140 SF	14.00	14.40	C-3	SF	2 5/16	5/16	5/8	2 1/16	5/8	20.0	2 C 140 SF	D-3	SF	2 5/16	5/16	5/16	2 1/16	7/16	35.0
1 C 150 SF	15.00	15.40	C-3	SF	2 5/16	5/16	5/8	2 1/16	5/8	21.0	2 C 150 SF	D-3	SF	2 5/16	5/16	5/16	2 1/16	7/16	39.0
1 C 160 SF	16.00	16.40	C-3	SF	2 5/16	5/16	5/8	2 1/16	5/8	24.0	2 C 160 SF	D-3	SF	2 5/16	5/16	5/16	2 1/16	7/16	43.0
1 C 180 SF	18.00	18.40	C-3	SF	2 5/16	5/16	5/8	2 1/16	5/8	27.0	2 C 180 SF	D-3	SF	2 5/16	5/16	5/16	2 1/16	7/16	48.0
1 C 200 SF	20.00	20.40	C-3	SF	2 5/16	5/16	5/8	2 1/16	5/8	31.0	2 C 200 SF	D-3	SF	2 5/16	5/16	5/16	2 1/16	7/16	55.0
1 C 240 SF	24.00	24.40	C-3	SF	2 5/16	5/16	5/8	2 1/16	5/8	37.0	2 C 240 SF	D-3	SF	2 5/16	5/16	5/16	2 1/16	7/16	65.0
	27.00	27.40									2 C 270 F	C-3	F	3 3/16	1 1/16	5/16	3%	107.0	
	30.00	30.40									2 C 300 F	C-3	F	3 3/16	1 1/16	5/16	3%	115.0	

☆ E and M dimensions are nominal and will vary depending on shaft tolerances. Type E sheaves are drilled for reverse mounting only. See page B-3 and B-4 for additional bushing dimensions.



# C Conventional Stock QD Sheaves

## QD Sheaves — C

8 Groove F = 8%											10 Groove F = 10%								
Part Number	PD	OD	Type	Bush	Bush Max. Bore	E	K	L Length Thru Bore	M	Wt. Less Bush	Part Number	Type	Bush	Bush Max. Bore	E	K	L Length Thru Bore	M	Wt. Less Bush
	C Belt																		
8 C 70 SF	7.00	7.40	A-1	SF	2 <sup>5</sup> / <sub>16</sub>	2 <sup>5</sup> / <sub>16</sub>	3	2 <sup>1</sup> / <sub>16</sub>	4	35.0	10 C 80 E	A-1	E	3 <sup>1</sup> / <sub>2</sub>	2 <sup>5</sup> / <sub>16</sub>	3 <sup>3</sup> / <sub>4</sub>	2 <sup>5</sup> / <sub>16</sub>	5 <sup>5</sup> / <sub>16</sub>	42.8
8 C 80 E	8.00	8.40	A-1	E	3 <sup>1</sup> / <sub>2</sub>	2 <sup>5</sup> / <sub>16</sub>	3 <sup>3</sup> / <sub>4</sub>	2 <sup>5</sup> / <sub>16</sub>	3 <sup>3</sup> / <sub>4</sub>	36.6	10 C 85 E	A-1	E	3 <sup>1</sup> / <sub>2</sub>	2 <sup>5</sup> / <sub>16</sub>	3 <sup>3</sup> / <sub>4</sub>	2 <sup>5</sup> / <sub>16</sub>	5 <sup>5</sup> / <sub>16</sub>	48.5
8 C 85 E	8.50	8.90	A-1	E	3 <sup>1</sup> / <sub>2</sub>	2 <sup>5</sup> / <sub>16</sub>	3 <sup>3</sup> / <sub>4</sub>	2 <sup>5</sup> / <sub>16</sub>	3 <sup>3</sup> / <sub>4</sub>	41.0	10 C 90 J	A-1	J	4 <sup>1</sup> / <sub>2</sub>	2 <sup>5</sup> / <sub>16</sub>	3 <sup>3</sup> / <sub>4</sub>	4 <sup>1</sup> / <sub>2</sub>	3 <sup>3</sup> / <sub>4</sub>	54.0
8 C 90 F	9.00	9.40	A-1	F	3 <sup>3</sup> / <sub>16</sub>	2 <sup>5</sup> / <sub>16</sub>	3 <sup>3</sup> / <sub>16</sub>	3 <sup>3</sup> / <sub>16</sub>	2 <sup>1</sup> / <sub>16</sub>	50.0	10 C 95 J	A-1	J	4 <sup>1</sup> / <sub>2</sub>	2 <sup>5</sup> / <sub>16</sub>	3 <sup>3</sup> / <sub>16</sub>	4 <sup>1</sup> / <sub>2</sub>	3 <sup>3</sup> / <sub>16</sub>	60.0
8 C 95 F	9.50	9.90	A-1	F	3 <sup>3</sup> / <sub>16</sub>	2 <sup>5</sup> / <sub>16</sub>	3 <sup>3</sup> / <sub>16</sub>	3 <sup>3</sup> / <sub>16</sub>	2 <sup>1</sup> / <sub>16</sub>	51.0	10 C 100 J	A-1	J	4 <sup>1</sup> / <sub>2</sub>	2 <sup>5</sup> / <sub>16</sub>	3 <sup>3</sup> / <sub>16</sub>	4 <sup>1</sup> / <sub>2</sub>	3 <sup>3</sup> / <sub>16</sub>	68.0
8 C 100 F	10.00	10.40	A-1	F	3 <sup>3</sup> / <sub>16</sub>	2 <sup>5</sup> / <sub>16</sub>	3 <sup>3</sup> / <sub>16</sub>	3 <sup>3</sup> / <sub>16</sub>	2 <sup>1</sup> / <sub>16</sub>	60.0	10 C 105 J	A-1	J	4 <sup>1</sup> / <sub>2</sub>	2 <sup>5</sup> / <sub>16</sub>	3 <sup>3</sup> / <sub>16</sub>	4 <sup>1</sup> / <sub>2</sub>	3 <sup>3</sup> / <sub>16</sub>	75.0
8 C 105 F	10.50	10.90	A-1	F	3 <sup>3</sup> / <sub>16</sub>	2 <sup>5</sup> / <sub>16</sub>	3 <sup>3</sup> / <sub>16</sub>	3 <sup>3</sup> / <sub>16</sub>	2 <sup>1</sup> / <sub>16</sub>	67.0	10 C 110 J	A-1	J	4 <sup>1</sup> / <sub>2</sub>	2 <sup>5</sup> / <sub>16</sub>	3 <sup>3</sup> / <sub>16</sub>	4 <sup>1</sup> / <sub>2</sub>	3 <sup>3</sup> / <sub>16</sub>	90.0
8 C 110 F	11.00	11.40	A-1	F	3 <sup>3</sup> / <sub>16</sub>	2 <sup>5</sup> / <sub>16</sub>	3 <sup>3</sup> / <sub>16</sub>	3 <sup>3</sup> / <sub>16</sub>	2 <sup>1</sup> / <sub>16</sub>	74.0	10 C 120 J	A-1	J	4 <sup>1</sup> / <sub>2</sub>	2 <sup>5</sup> / <sub>16</sub>	3 <sup>3</sup> / <sub>16</sub>	4 <sup>1</sup> / <sub>2</sub>	3 <sup>3</sup> / <sub>16</sub>	106.0
8 C 120 F	12.00	12.40	A-1	F	3 <sup>3</sup> / <sub>16</sub>	2 <sup>5</sup> / <sub>16</sub>	3 <sup>3</sup> / <sub>16</sub>	3 <sup>3</sup> / <sub>16</sub>	2 <sup>1</sup> / <sub>16</sub>	87.0	10 C 130 J	A-2	J	4 <sup>1</sup> / <sub>2</sub>	2 <sup>5</sup> / <sub>16</sub>	3 <sup>3</sup> / <sub>16</sub>	4 <sup>1</sup> / <sub>2</sub>	3 <sup>3</sup> / <sub>16</sub>	110.0
8 C 130 F	13.00	13.40	A-3	F	3 <sup>3</sup> / <sub>16</sub>	2 <sup>5</sup> / <sub>16</sub>	3 <sup>3</sup> / <sub>16</sub>	3 <sup>3</sup> / <sub>16</sub>	2 <sup>1</sup> / <sub>16</sub>	94.0	10 C 140 J	A-2	J	4 <sup>1</sup> / <sub>2</sub>	2 <sup>5</sup> / <sub>16</sub>	3 <sup>3</sup> / <sub>16</sub>	4 <sup>1</sup> / <sub>2</sub>	3 <sup>3</sup> / <sub>16</sub>	124.0
8 C 140 F	14.00	14.40	A-3	F	3 <sup>3</sup> / <sub>16</sub>	2 <sup>5</sup> / <sub>16</sub>	3 <sup>3</sup> / <sub>16</sub>	3 <sup>3</sup> / <sub>16</sub>	2 <sup>1</sup> / <sub>16</sub>	99.0	10 C 150 J	A-2	J	4 <sup>1</sup> / <sub>2</sub>	2 <sup>5</sup> / <sub>16</sub>	3 <sup>3</sup> / <sub>16</sub>	4 <sup>1</sup> / <sub>2</sub>	3 <sup>3</sup> / <sub>16</sub>	138.0
8 C 150 F	15.00	15.40	A-2	F	3 <sup>3</sup> / <sub>16</sub>	2 <sup>5</sup> / <sub>16</sub>	3 <sup>3</sup> / <sub>16</sub>	3 <sup>3</sup> / <sub>16</sub>	2 <sup>1</sup> / <sub>16</sub>	111.0	10 C 160 J	A-3	J	4 <sup>1</sup> / <sub>2</sub>	2 <sup>5</sup> / <sub>16</sub>	3 <sup>3</sup> / <sub>16</sub>	4 <sup>1</sup> / <sub>2</sub>	3 <sup>3</sup> / <sub>16</sub>	139.0
8 C 160 F	16.00	16.40	A-3	F	3 <sup>3</sup> / <sub>16</sub>	2 <sup>5</sup> / <sub>16</sub>	3 <sup>3</sup> / <sub>16</sub>	3 <sup>3</sup> / <sub>16</sub>	2 <sup>1</sup> / <sub>16</sub>	112.0	10 C 180 J	A-3	J	4 <sup>1</sup> / <sub>2</sub>	2 <sup>5</sup> / <sub>16</sub>	3 <sup>3</sup> / <sub>16</sub>	4 <sup>1</sup> / <sub>2</sub>	3 <sup>3</sup> / <sub>16</sub>	168.0
8 C 180 F	18.00	18.40	A-3	F	3 <sup>3</sup> / <sub>16</sub>	2 <sup>5</sup> / <sub>16</sub>	3 <sup>3</sup> / <sub>16</sub>	3 <sup>3</sup> / <sub>16</sub>	2 <sup>1</sup> / <sub>16</sub>	116.0	10 C 200 J	A-3	J	4 <sup>1</sup> / <sub>2</sub>	2 <sup>5</sup> / <sub>16</sub>	3 <sup>3</sup> / <sub>16</sub>	4 <sup>1</sup> / <sub>2</sub>	3 <sup>3</sup> / <sub>16</sub>	182.0
8 C 200 J	20.00	20.40	A-3	J	4 <sup>1</sup> / <sub>2</sub>	3 <sup>1</sup> / <sub>16</sub>	1 <sup>1</sup> / <sub>16</sub>	4 <sup>1</sup> / <sub>2</sub>	3 <sup>1</sup> / <sub>2</sub>	146.0	10 C 240 M	A-3	M	5 <sup>1</sup> / <sub>2</sub>	1 <sup>1</sup> / <sub>2</sub>	1 <sup>1</sup> / <sub>16</sub>	6 <sup>3</sup> / <sub>4</sub>	3 <sup>3</sup> / <sub>16</sub>	272.0
8 C 240 J	24.00	24.40	A-3	J	4 <sup>1</sup> / <sub>2</sub>	3 <sup>1</sup> / <sub>16</sub>	1 <sup>1</sup> / <sub>16</sub>	4 <sup>1</sup> / <sub>2</sub>	3 <sup>1</sup> / <sub>2</sub>	195.0	10 C 300 M	A-3	M	5 <sup>1</sup> / <sub>2</sub>	1 <sup>1</sup> / <sub>2</sub>	1 <sup>1</sup> / <sub>16</sub>	6 <sup>3</sup> / <sub>4</sub>	3 <sup>3</sup> / <sub>16</sub>	355.0
8 C 270 J	27.00	27.40	A-3	J	4 <sup>1</sup> / <sub>2</sub>	3 <sup>1</sup> / <sub>16</sub>	1 <sup>1</sup> / <sub>16</sub>	4 <sup>1</sup> / <sub>2</sub>	3 <sup>1</sup> / <sub>2</sub>	216.0	10 C 360 M	A-3	M	5 <sup>1</sup> / <sub>2</sub>	1 <sup>1</sup> / <sub>2</sub>	1 <sup>1</sup> / <sub>16</sub>	6 <sup>3</sup> / <sub>4</sub>	3 <sup>3</sup> / <sub>16</sub>	455.0
8 C 300 J	30.00	30.40	A-3	J	4 <sup>1</sup> / <sub>2</sub>	3 <sup>1</sup> / <sub>16</sub>	1 <sup>1</sup> / <sub>16</sub>	4 <sup>1</sup> / <sub>2</sub>	3 <sup>1</sup> / <sub>2</sub>	268.0	10 C 440 M	A-3	M	5 <sup>1</sup> / <sub>2</sub>	1 <sup>1</sup> / <sub>2</sub>	1 <sup>1</sup> / <sub>16</sub>	6 <sup>3</sup> / <sub>4</sub>	3 <sup>3</sup> / <sub>16</sub>	544.0
8 C 360 M	36.00	36.40	A-3	M	5 <sup>1</sup> / <sub>2</sub>	1 <sup>1</sup> / <sub>2</sub>	1 <sup>1</sup> / <sub>16</sub>	6 <sup>3</sup> / <sub>4</sub>	1 <sup>1</sup> / <sub>8</sub>	364.0	10 C 500 M	A-3	M	5 <sup>1</sup> / <sub>2</sub>	1 <sup>1</sup> / <sub>2</sub>	1 <sup>1</sup> / <sub>16</sub>	6 <sup>3</sup> / <sub>4</sub>	3 <sup>3</sup> / <sub>16</sub>	622.0
8 C 440 M	44.00	44.40	A-3	M	5 <sup>1</sup> / <sub>2</sub>	1 <sup>1</sup> / <sub>2</sub>	1 <sup>1</sup> / <sub>16</sub>	6 <sup>3</sup> / <sub>4</sub>	1 <sup>1</sup> / <sub>8</sub>	413.0									
8 C 500 M	50.00	50.40	A-3	M	5 <sup>1</sup> / <sub>2</sub>	1 <sup>1</sup> / <sub>2</sub>	1 <sup>1</sup> / <sub>16</sub>	6 <sup>3</sup> / <sub>4</sub>	1 <sup>1</sup> / <sub>8</sub>	474.0									

## QD Sheaves — C

12 Groove F = 12%										
Part Number	PD	OD	Type	Bush	Bush Max. Bore	E	K	L Thru Bore	M	Wt. Less Bush
	C Belt									
12 C 90 J	9.00	9.40	A-1	J	4 <sup>1</sup> / <sub>2</sub>	2 <sup>7</sup> / <sub>16</sub>	4 <sup>1</sup> / <sub>16</sub>	4 <sup>1</sup> / <sub>2</sub>	5	63.0
12 C 95 J	9.50	9.90	A-1	J	4 <sup>1</sup> / <sub>2</sub>	2 <sup>7</sup> / <sub>16</sub>	4 <sup>1</sup> / <sub>16</sub>	4 <sup>1</sup> / <sub>2</sub>	5	75.0
12 C 100 J	10.00	10.40	A-1	J	4 <sup>1</sup> / <sub>2</sub>	2 <sup>7</sup> / <sub>16</sub>	4 <sup>1</sup> / <sub>16</sub>	4 <sup>1</sup> / <sub>2</sub>	5	84.0
12 C 105 J	10.50	10.90	A-1	J	4 <sup>1</sup> / <sub>2</sub>	2 <sup>7</sup> / <sub>16</sub>	4 <sup>1</sup> / <sub>16</sub>	4 <sup>1</sup> / <sub>2</sub>	5	86.0
12 C 110 J	11.00	11.40	A-1	J	4 <sup>1</sup> / <sub>2</sub>	2 <sup>7</sup> / <sub>16</sub>	4 <sup>1</sup> / <sub>16</sub>	4 <sup>1</sup> / <sub>2</sub>	5	97.0
12 C 120 J	12.00	12.40	A-1	J	4 <sup>1</sup> / <sub>2</sub>	2 <sup>7</sup> / <sub>16</sub>	4 <sup>1</sup> / <sub>16</sub>	4 <sup>1</sup> / <sub>2</sub>	5	119.0
12 C 130 J	13.00	13.40	A-2	J	4 <sup>1</sup> / <sub>2</sub>	2 <sup>7</sup> / <sub>16</sub>	4 <sup>1</sup> / <sub>16</sub>	4 <sup>1</sup> / <sub>2</sub>	5	125.0
12 C 140 J	14.00	14.40	A-2	J	4 <sup>1</sup> / <sub>2</sub>	2 <sup>7</sup> / <sub>16</sub>	4 <sup>1</sup> / <sub>16</sub>	4 <sup>1</sup> / <sub>2</sub>	5	139.0
12 C 150 J	15.00	15.40	A-2	J	4 <sup>1</sup> / <sub>2</sub>	2 <sup>7</sup> / <sub>16</sub>	4 <sup>1</sup> / <sub>16</sub>	4 <sup>1</sup> / <sub>2</sub>	5	156.0
12 C 160 J	16.00	16.40	A-3	J	4 <sup>1</sup> / <sub>2</sub>	2 <sup>7</sup> / <sub>16</sub>	4 <sup>1</sup> / <sub>16</sub>	4 <sup>1</sup> / <sub>2</sub>	5	175.0
12 C 180 J	18.00	18.40	A-3	J	4 <sup>1</sup> / <sub>2</sub>	2 <sup>7</sup> / <sub>16</sub>	4 <sup>1</sup> / <sub>16</sub>	4 <sup>1</sup> / <sub>2</sub>	5	185.0
12 C 200 M	20.00	20.40	A-3	M	5 <sup>1</sup> / <sub>2</sub>	1 <sup>1</sup> / <sub>2</sub>	1 <sup>1</sup> / <sub>16</sub>	6 <sup>3</sup> / <sub>4</sub>	5 <sup>5</sup> / <sub>8</sub>	228.0
12 C 240 M	24.00	24.40	A-3	M	5 <sup>1</sup> / <sub>2</sub>	1 <sup>1</sup> / <sub>2</sub>	1 <sup>1</sup> / <sub>16</sub>	6 <sup>3</sup> / <sub>4</sub>	5 <sup>5</sup> / <sub>8</sub>	287.0
12 C 300 M	30.00	30.40	A-3	M	5 <sup>1</sup> / <sub>2</sub>	1 <sup>1</sup> / <sub>2</sub>	1 <sup>1</sup> / <sub>16</sub>	6 <sup>3</sup> / <sub>4</sub>	5 <sup>5</sup> / <sub>8</sub>	350.0
12 C 360 M	36.00	36.40	A-3	M	5 <sup>1</sup> / <sub>2</sub>	1 <sup>1</sup> / <sub>2</sub>	1 <sup>1</sup> / <sub>16</sub>	6 <sup>3</sup> / <sub>4</sub>	5 <sup>5</sup> / <sub>8</sub>	430.0
12 C 440 M	44.00	44.40	A-3	M	5 <sup>1</sup> / <sub>2</sub>	1 <sup>1</sup> / <sub>2</sub>	1 <sup>1</sup> / <sub>16</sub>	6 <sup>3</sup> / <sub>4</sub>	5 <sup>5</sup> / <sub>8</sub>	565.0
12 C 500 M	50.00	50.40	A-3	M	5 <sup>1</sup> / <sub>2</sub>	1 <sup>1</sup> / <sub>2</sub>	1 <sup>1</sup> / <sub>16</sub>	6 <sup>3</sup> / <sub>4</sub>	5 <sup>5</sup> / <sub>8</sub>	595.0

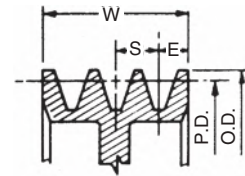

Combination Groove Dimensions

Belt Section	E	S	OD
"C"	1 <sup>1</sup> / <sub>16</sub>	1	P.D. + .40

W = S(N-1) + 2E  
N = No. of Grooves

Dimensions in inches, weight in pounds. Weights do not include bushings. See page B-3 and B-4 for additional bushing dimensions.



## QD Sheaves — C

3 Groove F = 4%											4 Groove F = 6%								
Part Number	PD	OD	Type	Bush	Bush Max. Bore	E	K	L Thru Bore	M	Wt. Less Bush	Part Number	Type	Bush	Bush Max. Bore	E	K	L Thru Bore	M	Wt. Less Bush
	D Belt																		
3 D 120 F	12.0	12.6	A-2	F	3 <sup>1</sup> / <sub>16</sub>	1/2	1 1/2	3%	1/2	58.0	4 D 120 F	A-2	F	3 <sup>15</sup> / <sub>16</sub>	1 1/16	2 5/16	3%	1 1/8	68.0
3 D 130 F	13.0	13.6	A-2	F	3 <sup>1</sup> / <sub>16</sub>	1/2	1 1/2	3%	1/2	63.0	4 D 130 F	A-2	F	3 <sup>1</sup> / <sub>16</sub>	1 1/16	2 5/16	3%	1 1/8	78.0
3 D 135 F	13.5	14.1	A-2	F	3 <sup>1</sup> / <sub>16</sub>	1/2	1 1/2	3%	1/2	68.0	4 D 135 F	A-2	F	3 <sup>1</sup> / <sub>16</sub>	1 1/16	2 5/16	3%	1 1/8	82.0
3 D 140 F	14.0	14.6	A-2	F	3 <sup>1</sup> / <sub>16</sub>	1/2	1 1/2	3%	1/2	71.0	4 D 140 F	A-2	F	3 <sup>1</sup> / <sub>16</sub>	1 1/16	2 5/16	3%	1 1/8	91.0
3 D 145 F	14.5	15.1	A-2	F	3 <sup>1</sup> / <sub>16</sub>	1/2	1 1/2	3%	1/2	82.0	4 D 145 F	A-2	F	3 <sup>1</sup> / <sub>16</sub>	1 1/16	2 5/16	3%	1 1/8	93.0
3 D 150 F	15.0	15.6	A-2	F	3 <sup>1</sup> / <sub>16</sub>	1/2	1 1/2	3%	1/2	86.0	4 D 150 F	A-2	F	3 <sup>1</sup> / <sub>16</sub>	1 1/16	2 5/16	3%	1 1/8	99.0
3 D 155 F	15.5	16.1	A-2	F	3 <sup>1</sup> / <sub>16</sub>	1/2	1 1/2	3%	1/2	93.0	4 D 155 F	A-2	F	3 <sup>1</sup> / <sub>16</sub>	1 1/16	2 5/16	3%	1 1/8	111.0
3 D 160 F	16.0	16.6	A-2	F	3 <sup>1</sup> / <sub>16</sub>	1/2	1 1/2	3%	1/2	95.0	4 D 160 F	A-2	F	3 <sup>1</sup> / <sub>16</sub>	1 1/16	2 5/16	3%	1 1/8	122.0
3 D 180 J	18.0	18.6	A-3	J	4 1/2	0	1 3/16	4 1/2	1/8	105.0	4 D 170 J	A-2	J	4 1/2	1 1/16	2 5/16	4 1/2	3/16	136.0
3 D 200 J	20.0	20.6	A-2	J	4 1/2	0	1 3/16	4 1/2	1/8	148.0	4 D 180 J	A-3	J	4 1/2	1 1/16	2 5/16	4 1/2	3/16	141.0
3 D 220 J	22.0	22.6	A-3	J	4 1/2	0	1 3/16	4 1/2	1/8	164.0	4 D 200 J	A-2	J	4 1/2	1 1/16	2 5/16	4 1/2	1 1/16	167.0
3 D 270 J	27.0	27.6	A-3	J	4 1/2	0	1 3/16	4 1/2	1/8	180.0	4 D 220 J	A-3	J	4 1/2	1 1/16	2 5/16	4 1/2	1 1/16	183.0
3 D 330 J	33.0	33.6	A-3	J	4 1/2	0	1 3/16	4 1/2	1/8	195.0	4 D 270 J	A-3	J	4 1/2	1 1/16	2 5/16	4 1/2	1 1/16	222.0
3 D 400 J	40.0	40.6	A-3	J	4 1/2	0	1 3/16	4 1/2	1/8	260.0	4 D 330 M	B-3	M	5 1/2	1 1/16	6 3/4	6 3/4	1 1/16	315.0
											4 D 400 M	B-3	M	5 1/2	1 1/16	6 3/4	6 3/4	1 1/16	337.0

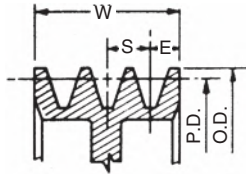

Groove Dimensions

Belt Section	E	S	O.D.
"D"	7/8	1 1/16	P.D. + .60

W = S(N-1) + 2E  
N = No. of Grooves

## QD Sheaves — C

5 Groove F = 7 1/2%											
Part Number	PD	OD	Belt	Type	Bush	Bush Max. Bore	E	K	L Thru Bore	M	Wt. Less Bush
	D Belt										
5 D 120 F	12.0	12.6	A-2	F	3 <sup>1</sup> / <sub>16</sub>	2 1/16	3 1/16	3%	1 1/16	87.0	
5 D 130 F	13.0	13.6	A-2	F	3 <sup>1</sup> / <sub>16</sub>	2 1/16	3 1/16	3%	1 1/16	88.0	
5 D 135 F	13.5	14.1	A-2	F	3 <sup>1</sup> / <sub>16</sub>	2 1/16	3 1/16	3%	1 1/16	92.0	
5 D 140 F	14.0	14.6	A-2	F	3 <sup>1</sup> / <sub>16</sub>	2 1/16	3 1/16	3%	1 1/16	96.0	
5 D 145 F	14.5	15.1	A-2	F	3 <sup>1</sup> / <sub>16</sub>	2 1/16	3 1/16	3%	1 1/16	111.0	
5 D 150 F	15.0	15.6	A-2	F	3 <sup>1</sup> / <sub>16</sub>	2 1/16	3 1/16	3%	1 1/16	115.0	
5 D 155 F	15.5	16.1	A-2	F	3 <sup>1</sup> / <sub>16</sub>	2 1/16	3 1/16	3%	1 1/16	121.0	
5 D 160 F	16.0	16.6	A-2	F	3 <sup>1</sup> / <sub>16</sub>	2 1/16	3 1/16	3%	1 1/16	128.0	
5 D 170 J	17.0	17.6	A-2	J	4 1/2	3/8	1 9/16	4 1/2	2 5/8	135.0	
5 D 180 J	18.0	18.6	A-3	J	4 1/2	3/8	1 9/16	4 1/2	2 5/8	148.0	
5 D 200 J	20.0	20.6	A-3	J	4 1/2	3/8	1 9/16	4 1/2	2 5/8	184.0	
5 D 220 J	22.0	22.6	A-3	J	4 1/2	3/8	1 9/16	4 1/2	2 5/8	202.0	
5 D 270 M	27.0	27.6	A-3	M	5 1/2	1/2	1 15/16	6 3/4	1/4	250.0	
5 D 330 M	33.0	33.6	A-3	M	5 1/2	1/2	1 15/16	6 3/4	1/4	280.0	
5 D 400 M	40.0	40.6	A-3	M	5 1/2	1/2	1 15/16	6 3/4	1/4	380.0	

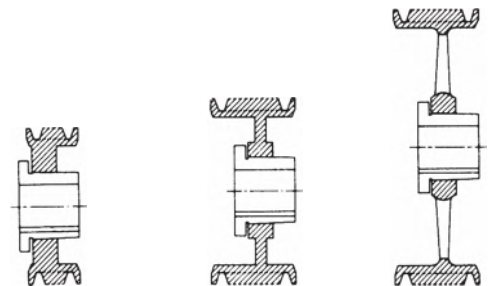

1 = SOLID

2 = WEB

3 = ARM/SPOKE

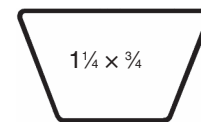

D

Dimensions in inches, weight in pounds. Weights do not include bushings. See page B-3 an B-4 for additional bushing dimensions.

